

STANLEY®

SM20 HYDRAULIC SUMP PUMP



USER MANUAL Safety, Operation and Maintenance



© 2014 STANLEY Black & Decker, Inc.
New Britain, CT 06053
U.S.A.
66393 6/2018 Ver. 15

DECLARATION OF CONFORMITY

DECLARATION OF CONFORMITY
ÜBEREINSTIMMUNGS-ERKLÄRUNG
DECLARATION DE CONFORMITE CEE
DECLARACION DE CONFORMIDAD
DICHIARAZIONE DI CONFORMITA



I, the undersigned:
Ich, der Unterzeichnende:
Je soussigné:
El abajo firmante:
Io sottoscritto:

Weisbeck, Andy

Surname and First names/Familiennamen und Vornamen/Nom et prénom/Nombre y apellido/Cognome e nome

hereby declare that the equipment specified hereunder:
bestätige hiermit, daß erklaren Produkt genannten Werk oder Gerät:
déclare que l'équipement visé ci-dessous:
Por la presente declaro que el equipo se especifica a continuación:
Dichiaro che le apparecchiature specificate di seguito:

- Category: **Submersible Pump, Hydraulic**
Kategorie:
Catégorie:
Categoria:
Categoria:
- Make/Marke/Marque/Marca/Marca **Stanley**
- Type/Typ/Type/Tipo/Tipo: **SM2043101, SM2043107, SM2052101, SM2053101**
- Serial number of equipment:
Seriennummer des Geräts:
Numéro de série de l'équipement:
Numero de serie del equipo:
Matricola dell'attrezzatura:
All

Has been manufactured in conformity with
Wurde hergestellt in Übereinstimmung mit
Est fabriqué conformément
Ha sido fabricado de acuerdo con
E' stata costruita in conformità con

Directive/Standards Richtlinie/Standards Directives/Normes Directriz/Los Normas Direttiva/Norme	No. Nr Numéro No n.	Approved body Prüfung durch Organisme agréé Aprobado Collaudato
EN Machinery Directive	809:1998+A1:2009 2006/42/EC:2006	Self Self

- Special Provisions: **None**
Spezielle Bestimmungen:
Dispositions particulières:
Provisiones especiales:
Disposizioni speciali:
- Representative in the Union: **Patrick Vervier, Stanley Dubuis 17-19, rue Jules Berthonneau-BP 3406 41034 Blois Cedex, France.**
Vertreter in der Union/Représentant dans l'union/Representante en la Union/Rappresentante presso l'Unione

Done at/Ort/Fait à/Dado en/Fatto a Stanley Hydraulic Tools, Milwaukie, Oregon USA Date/Datum/le/Fecha/Data 1-5-11

Signature/Unterschrift/Signature/Firma/Firma

Position/Position/Fonction/Cargo/Posizione Director of Product Development

TABLE OF CONTENTS

SAFETY SYMBOLS.....	4
SAFETY PRECAUTIONS	5
TOOL STICKERS & TAGS	6
HOSE TYPES	7
HOSE RECOMMENDATIONS.....	8
HTMA / EHTMA REQUIREMENTS	9
OPERATION	10
TOOL PROTECTION & CARE.....	12
TROUBLESHOOTING	13
SPECIFICATIONS	14
SM20 PARTS ILLUSTRATION.....	15
SM20 PARTS LIST.....	16
UNDERWATER TOOLS DEPTH GUIDELINE	17

IMPORTANT

To fill out a product warranty validation form, and for information on your warranty, visit www.stanleyinfrastructure.com and select the Company tab > Warranty.

Note: The warranty validation record must be submitted to validate the warranty.

SERVICING: This manual contains safety, operation and routine maintenance instructions. STANLEY Infrastructure recommends that servicing of hydraulic tools, other than routine maintenance, must be performed by an authorized and certified dealer. Please read the following warning.

⚠ WARNING

SERIOUS INJURY OR DEATH COULD RESULT FROM THE IMPROPER REPAIR OR SERVICE OF THIS TOOL.

REPAIRS AND / OR SERVICE TO THIS TOOL MUST ONLY BE DONE BY AN AUTHORIZED AND CERTIFIED DEALER.

For the nearest certified dealer, call STANLEY Infrastructure at (503) 659-5660 and ask for a Customer Service Representative.

SAFETY PRECAUTIONS

Tool operators and maintenance personnel must always comply with the safety precautions given in this manual and on the stickers and tags attached to the tool and hose.

These safety precautions are given for your safety. Review them carefully before operating the tool and before performing general maintenance or repairs.

Supervising personnel should develop additional precautions relating to the specific work area and local safety regulations. If so, place the added precautions in the space provided in this manual.

The models SM20 Hydraulic Pump will provide safe and dependable service if operated in accordance with the instructions given in this manual. Read and understand this manual and any stickers and tags attached to the pump and hoses before operation. Failure to do so could result in personal injury or equipment damage.



- Operator must start in a work area without bystanders. The operator must be familiar with all prohibited work areas such as excessive slopes and dangerous terrain conditions.
- Establish a training program for all operators to ensure safe operations.
- Do not operate the tool unless thoroughly trained or under the supervision of an instructor.
- Always wear safety equipment such as goggles, head protection and safety shoes at all times when operating the tool.
- Do not inspect or clean the tool while the hydraulic power source is connected. Accidental engagement of the tool can cause serious injury.
- Do not operate this tool without first reading the Operation section of this manual.
- Do not install or remove this tool while the hydraulic power source is connected. Accidental engagement of the tool can cause serious injury.
- Never operate the tool near energized transmission lines. Know the location of buried or covered services before starting work.
- Do not wear loose fitting clothing when operating the tool. Loose fitting clothing can become entangled with the tool and cause serious injury.
- Supply hoses must have a minimum working pressure rating of 2500 psi/175 bar.
- Be sure all hose connections are tight.
- The hydraulic circuit control valve must be in the "OFF" position when coupling or uncoupling the tool. Wipe all couplers clean before connecting. Failure to do so may result in damage to the quick couplers and cause overheating. Use only lint-free cloths.
- Do not operate the tool at oil temperatures above 140 °F/60 °C. Operation at higher oil temperatures can cause operator discomfort and may cause damage to the tool.
- Do not operate a damaged, improperly adjusted or incompletely assembled tool.
- Do not put hand under volute while the pump is running.
- To avoid personal injury or equipment damage, all tool repair, maintenance and service must only be performed by authorized and properly trained personnel.
- Do not exceed the rated limits of the tool or use the tool for applications beyond its design capacity.
- Always keep critical tool markings, such as labels and warning stickers, legible.
- Always replace parts with replacement parts recommended by STANLEY.
- Check fastener tightness often and before each use daily.
- Do not point water discharge at bystanders.

TOOL STICKERS & TAGS



28323
CE Decal (CE Only)



11207
Circuit Type C Decal (CE Only)

STANLEY. Stanley Hydraulic Tools 3810 SE Naef Rd Milwaukie, Oregon 97267 U.S.A.	
Model No.	15-23 lpm/4-6 gpm
SM20	172 bar/2500 psi

74762
Model Decal 20 LPM (SM2052101 Only)



28788
Manual Decal

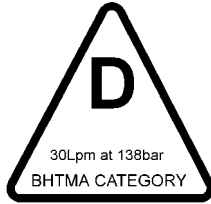

11206
Circuit Type D Decal (CE Only)
(SM2052101 Only)

STANLEY. Stanley Hydraulic Tools 3810 SE Naef Rd Milwaukie, Oregon 97267 U.S.A.	
Model No.	26-34 lpm/7-9 gpm
SM20	172 bar/2500 psi

74761
Model Decal 30 LPM

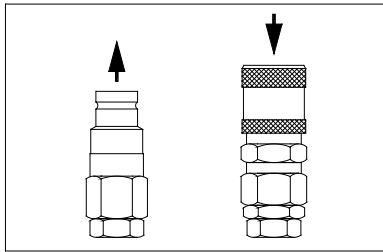

28786
Coupler Decal

NOTE:
THE INFORMATION LISTED ON THE STICKERS SHOWN, MUST BE LEGIBLE AT ALL TIMES.
REPLACE DECALS IF THEY BECOME WORN OR DAMAGED. REPLACEMENTS ARE AVAILABLE FROM YOUR LOCAL STANLEY DISTRIBUTOR.

The safety tag (P/N 15875) at right is attached to the tool when shipped from the factory. Read and understand the safety instructions listed on this tag before removal. We suggest you retain this tag and attach it to the tool when not in use.

DANGER

1. FAILURE TO USE HYDRAULIC HOSE LABELED AND CERTIFIED AS NON-CONDUCTIVE WHEN USING HYDRAULIC TOOLS ON OR NEAR ELECTRICAL LINES MAY RESULT IN DEATH OR SERIOUS INJURY.
BEFORE USING HOSE LABELED AND CERTIFIED AS NON-CONDUCTIVE ON OR NEAR ELECTRICAL LINES BE SURE THE HOSE IS MAINTAINED AS NON-CONDUCTIVE. THE HOSE SHOULD BE REGULARLY TESTED FOR ELECTRIC CURRENT LEAKAGE IN ACCORDANCE WITH YOUR SAFETY DEPARTMENT INSTRUCTIONS.
2. A HYDRAULIC LEAK OR BURST MAY CAUSE OIL INJECTION INTO THE BODY OR CAUSE OTHER SEVERE PERSONAL INJURY.
 - A. **DO NOT** EXCEED SPECIFIED FLOW AND PRESSURE FOR THIS TOOL. EXCESS FLOW OR PRESSURE MAY CAUSE A LEAK OR BURST.
 - B. **DO NOT** EXCEED RATED WORKING PRESSURE OF HYDRAULIC HOSE USED WITH THIS TOOL. EXCESS PRESSURE MAY CAUSE A LEAK OR BURST.
 - C. CHECK TOOL HOSE COUPLERS AND CONNECTORS DAILY FOR LEAKS. **DO NOT** FEEL FOR LEAKS WITH YOUR HANDS. CONTACT WITH A LEAK MAY RESULT IN SEVERE PERSONAL INJURY.

IMPORTANT

READ OPERATION MANUAL AND SAFETY INSTRUCTIONS FOR THIS TOOL BEFORE USING IT.

USE ONLY PARTS AND REPAIR PROCEDURES APPROVED BY STANLEY AND DESCRIBED IN THE OPERATION MANUAL.

TAG TO BE REMOVED ONLY BY TOOL OPERATOR.

SEE OTHER SIDE

DANGER

- D. DO NOT LIFT OR CARRY TOOL BY THE HOSES. DO NOT ABUSE HOSE. DO NOT USE KINKED, TORN OR DAMAGED HOSE.
3. MAKE SURE HYDRAULIC HOSES ARE PROPERLY CONNECTED TO THE TOOL BEFORE PRESSURING SYSTEM. SYSTEM PRESSURE HOSE MUST ALWAYS BE CONNECTED TO TOOL "IN" PORT. SYSTEM RETURN HOSE MUST ALWAYS BE CONNECTED TO TOOL "OUT" PORT. REVERSING CONNECTIONS MAY CAUSE REVERSE TOOL OPERATION WHICH CAN RESULT IN SEVERE PERSONAL INJURY.
4. DO NOT CONNECT OPEN-CENTER TOOLS TO CLOSED-CENTER HYDRAULIC SYSTEMS. THIS MAY RESULT IN LOSS OF OTHER HYDRAULIC FUNCTIONS POWERED BY THE SAME SYSTEM AND/OR SEVERE PERSONAL INJURY.
5. BYSTANDERS MAY BE INJURED IN YOUR WORK AREA. KEEP BYSTANDERS CLEAR OF YOUR WORK AREA.
6. WEAR HEARING, EYE, FOOT, HAND AND HEAD PROTECTION.
7. TO AVOID PERSONAL INJURY OR EQUIPMENT DAMAGE, ALL TOOL REPAIR MAINTENANCE AND SERVICE MUST ONLY BE PERFORMED BY AUTHORIZED AND PROPERLY TRAINED PERSONNEL.

IMPORTANT

READ OPERATION MANUAL AND SAFETY INSTRUCTIONS FOR THIS TOOL BEFORE USING IT.

USE ONLY PARTS AND REPAIR PROCEDURES APPROVED BY STANLEY AND DESCRIBED IN THE OPERATION MANUAL.

TAG TO BE REMOVED ONLY BY TOOL OPERATOR.

SEE OTHER SIDE

SAFETY TAG P/N 15875 (Shown smaller than actual size)

HOSE TYPES

The rated working pressure of the hydraulic hose must be equal to or higher than the relief valve setting on the hydraulic system. There are three types of hydraulic hose that meet this requirement and are authorized for use with STANLEY hydraulic tools. They are:

Certified non-conductive — constructed of thermoplastic or synthetic rubber inner tube, synthetic fiber braid reinforcement, and weather resistant thermoplastic or synthetic rubber cover. *Hose labeled **certified non-conductive** is the only hose authorized for use near electrical conductors.*

Wire-braided (conductive) — constructed of synthetic rubber inner tube, single or double wire braid reinforcement, and weather resistant synthetic rubber cover. *This hose is **conductive** and must never be used near electrical conductors.*

Fabric-braided (not certified or labeled non-conductive) — constructed of thermoplastic or synthetic rubber inner tube, synthetic fiber braid reinforcement, and weather resistant thermoplastic or synthetic rubber cover. *This hose is **not certified non-conductive** and must never be used near electrical conductors.*

HOSE SAFETY TAGS

To help ensure your safety, the following DANGER tags are attached to all hose purchased from STANLEY. DO NOT REMOVE THESE TAGS.

If the information on a tag is illegible because of wear or damage, replace the tag immediately. A new tag may be obtained from your STANLEY Distributor.

THE TAG SHOWN BELOW IS ATTACHED TO “CERTIFIED NON-CONDUCTIVE” HOSE

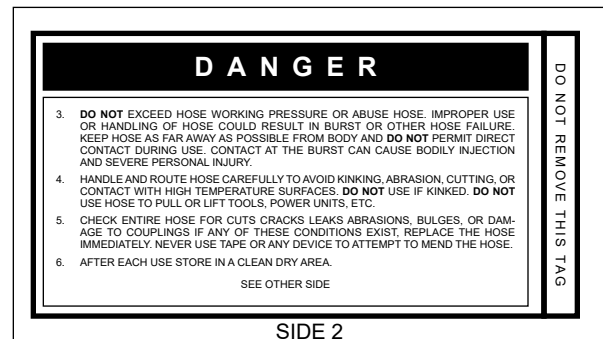
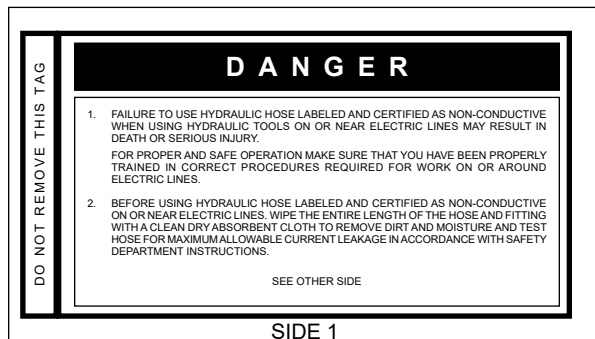

(Shown smaller than actual size)

THE TAG SHOWN BELOW IS ATTACHED TO “CONDUCTIVE” HOSE.

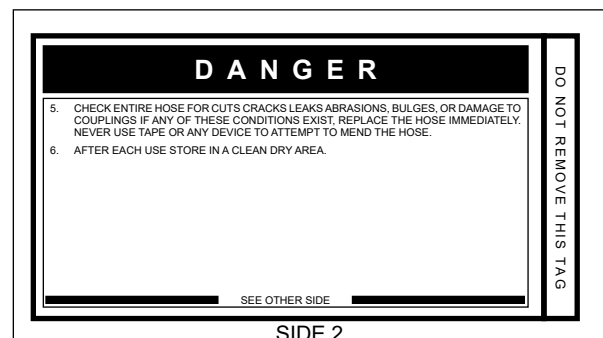
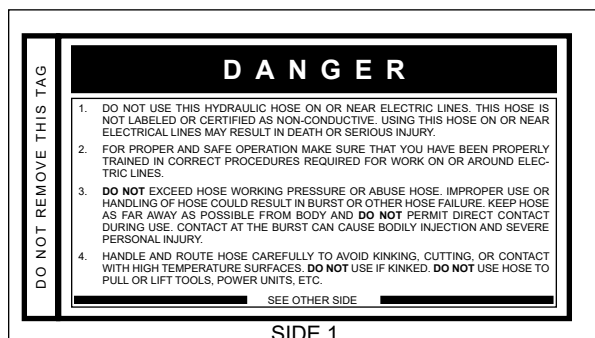

(Shown smaller than actual size)

HOSE RECOMMENDATIONS

Tool to Hydraulic Circuit Hose Recommendations

The chart to the right shows recommended minimum hose diameters for various hose lengths based on gallons per minute (GPM)/liters per minute (LPM). These recommendations are intended to keep return line pressure (back pressure) to a minimum acceptable level to ensure maximum tool performance.

This chart is intended to be used for hydraulic tool applications only based on STANLEY tool operating requirements and should not be used for any other applications.

All hydraulic hose must have at least a rated minimum working pressure equal to the maximum hydraulic system relief valve setting.

All hydraulic hose must meet or exceed specifications as set forth by SAE J517.

Oil Flow		Hose Lengths		Inside Diameter		USE (Press/Return)	Min. Working Pressure	
GPM	LPM	FEET	METERS	INCH	MM		PSI	BAR
Certified Non-Conductive Hose - Fiber Braid - for Utility Bucket Trucks								
4-9	15-34	up to 10	up to 3	3/8	10	Both	2250	155
Conductive Hose - Wire Braid or Fiber Braid - DO NOT USE NEAR ELECTRICAL CONDUCTORS								
4-6	15-23	up to 25	up to 7.5	3/8	10	Both	2500	175
4-6	15-23	26-100	7.5-30	1/2	13	Both	2500	175
5-10.5	19-40	up to 50	up to 15	1/2	13	Both	2500	175
5-10.5	19-40	51-100	15-30	5/8	16	Both	2500	175
5-10.5	19-40	100-300	30-90	5/8	16	Pressure	2500	175
10-13	38-49	up to 50	up to 15	3/4	19	Return	2500	175
10-13	38-49	51-100	15-30	5/8	16	Both	2500	175
10-13	38-49	100-200	30-60	3/4	19	Pressure	2500	175
13-16	49-60	up to 25	up to 8	1	25.4	Return	2500	175
13-16	49-60	26-100	8-30	5/8	16	Pressure	2500	175
				3/4	19	Return	2500	175
				3/4	19	Pressure	2500	175
				1	25.4	Return	2500	175

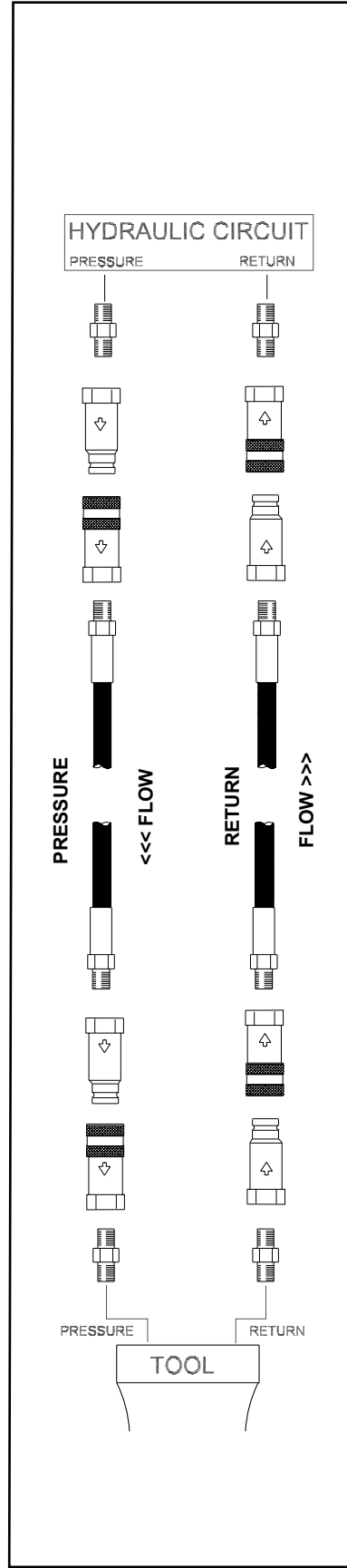

Figure 1. Typical Hose Connections





HTMA / EHTMA REQUIREMENTS

HTMA / EHTMA REQUIREMENTS

TOOL TYPE

HTMA HYDRAULIC SYSTEM REQUIREMENTS	TYPE I	TYPE II	TYPE RR	TYPE III
Flow range	4-6 GPM (15-23 LPM)	7-9 GPM (26-34 LPM)	9-10.5 GPM (34-40 LPM)	11-13 GPM (42-49 LPM)
Nominal operating pressure (At the power supply outlet)	1500 psi (103 bar)	1500 psi (103 bar)	1500 psi (103 bar)	1500 psi (103 bar)
System relief valve setting (At the power supply outlet)	2100-2250 psi (145-155 bar)	2100-2250 psi (145-155 bar)	2200-2300 psi (152-159 bar)	2100-2250 psi (145-155 bar)
Maximum back pressure (At tool end of the return hose)	250 psi (17 bar)	250 psi (17 bar)	250 psi (17 bar)	250 psi (17 bar)
Measured at a max fluid viscosity of: (At minimum operating temperature)	400 ssu* (82 centistokes)	400 ssu* (82 centistokes)	400 ssu* (82 centistokes)	400 ssu* (82 centistokes)
Temperature: Sufficient heat rejection capacity to limit maximum fluid temperature to: (At maximum expected ambient temperature)	140° F (60° C)	140° F (60° C)	140° F (60° C)	140° F (60° C)
Minimum cooling capacity at a temperature difference of between ambient and fluid temps	3 hp (2.24 kW) 40° F (22° C)	5 hp (3.73 kW) 40° F (22° C)	6 hp (5.22 kW) 40° F (22° C)	7 hp (4.47 kW) 40° F (22° C)
Note: Do not operate the tool at oil temperatures above 140° F (60° C). Operation at higher temperatures can cause operator discomfort at the tool.				
Filter minimum full-flow filtration Sized for flow of at least: (For cold temp startup and maximum dirt-holding capacity)	25 microns 30 GPM (114 LPM)	25 microns 30 GPM (114 LPM)	25 microns 30 GPM (114 LPM)	25 microns 30 GPM (114 LPM)
Hydraulic fluid, petroleum based (premium grade, anti- wear, non-conductive) Viscosity (at minimum and maximum operating temps)	100-400 ssu (20-82 centistokes)	100-400 ssu (20-82 centistokes)	100-400 ssu (20-82 centistokes)	100-400 ssu (20-82 centistokes)
Note: When choosing hydraulic fluid, the expected oil temperature extremes that will be experienced in service determine the most suitable temperature viscosity characteristics. Hydraulic fluids with a viscosity index over 140 will meet the requirements over a wide range of operating temperatures.				
*SSU = Saybolt Seconds Universal				

CLASSIFICATION

EHTMA HYDRAULIC SYSTEM REQUIREMENTS					
Flow range	3.5-4.3 GPM (13.5-16.5 LPM)	4.7-5.8 GPM (18-22 LPM)	7.1-8.7 GPM (27-33 LPM)	9.5-11.6 GPM (36-44 LPM)	11.8-14.5 GPM (45-55 LPM)
Nominal operating pressure (At the power supply outlet)	1870 psi (129 bar)	1500 psi (103 bar)	1500 psi (103 bar)	1500 psi (103 bar)	1500 psi (103 bar)
System relief valve setting (At the power supply outlet)	2495 psi (172 bar)	2000 psi (138 bar)	2000 psi (138 bar)	2000 psi (138 bar)	2000 psi (138 bar)

Note: These are general hydraulic system requirements. See tool specification page for tool specific requirements.

OPERATION

PREPARATION PROCEDURES

CHECK POWER SOURCE

1. Using a calibrated flow meter and pressure gauge, make sure the hydraulic power source develops a flow of 4–6 GPM/15–23 LPM at 1000–2000 psi/70–140 bar or 7–9 GPM/26–34 LPM at 1000–2000 psi/70/140 bar.
2. Make certain that the power source is equipped with a relief valve set to open at 2100 psi/145 bar maximum.
3. Make certain that the power source return pressure does not exceed 250 psi/17 bar.
4. Make sure the pump inlet screen is clear of debris and the outlet hose is clean. Remove any obstruction before operating. Refer to “Cleaning the Pumping chamber” on page 11.

CONNECT HOSES

1. Wipe all hose couplers with a clean lint free cloth before making connections.
2. Connect the hoses from the hydraulic power source to the couplers on the sump pump. Connect the return hose first and disconnect it last to minimize trapped pressure within the trash pump motor.

NOTE: If uncoupled hoses are left in the sun, pressure increase inside the hoses might make them difficult to connect. Whenever possible, connect the free ends of the hoses together.

3. Observe the arrow on the couplers to ensure that the flow is in the proper direction. The female coupler on the sump pump is the inlet (pressure) coupler.

PUMP OPERATION

1. Observe all safety precautions.

NOTE: The SM20 is not designed for use with a suction pipe inlet. The diameter of the suction screen at the bottom of the pump provides maximum pump efficiency. Reducing the size of this inlet will greatly reduce pump performance.

2. Connect a hose fitted with a 2-1/2 inch/63.5 mm male pipe end to the pump outlet fitting. Make sure the fitting is securely tightened. For best performance, keep the hose as short as possible and lay it out to avoid sharp bends or kinks.
3. Lower the pump into the liquid to be pumped. Locate the outlet end of the discharge hose to disperse the liquid as required. Remove any kinks from the hose to assure maximum water flow.

NOTICE

Never point the hose at bystanders.

4. Turn on the hydraulic power source. Watch for solids in the liquid being pumped. If solids are excessive, the discharge flow might decrease. If this happens, stop the pump and check for the cause of the problem.

Under some conditions, the liquid being pumped might be slowed enough so it can no longer push particles in the liquid. If this happens, particles can accumulate in the hose and backup the pumping chamber, causing further restriction. The impeller then acts as a “grinding wheel which causes accelerated pump wear. Reduced liquid flow can be caused by the following:

- The pump sinks into solids at the bottom of the hole.
 - The end of the outlet hose is too high, causing an excessive lift height for the column of liquid being pushed by the sump pump. This slows the flow of liquid to a level where it can no longer carry solids out the end of the hose.
 - The flow and pressure of hydraulic fluid to the pump is too low, which reduces impeller speed. A 20% decrease in hydraulic fluid flow can reduce pump performance by 50%. When operating at reduced hydraulic flow and pressure, the end of the outlet hose should not be more than 40 ft/12 m above the liquid.
5. When pumping is complete, set the hydraulic control valve to the “OFF” position. Lift the pump from the work area.

WHEN PUMPING WATER MIXED WITH SOLIDS

- Do not use a nozzle.
- Remove all hose kinks before starting the pump.
- Do not lift water mixed with solids over 40 ft/12 m if hydraulic flow from the power source is less than 7 GPM/26 LPM.
- If output flow from the water hose drops during operation, clean out the hose to remove all obstructions. Check for kinks in the hose.

OPERATION

NOTE: Always keep water speed as fast as possible during operation. This helps to pump solids through the hose and keeps the pump clean for longer life.

COLD WEATHER OPERATION

If the sump pump is to be used during cold weather, preheat the hydraulic fluid at low power source speed. When using the normally recommended fluids, fluid should be at or above 50 °F/10 °C (400 ssu/82 centistokes) before use.

Damage to the hydraulic system or pump motor seals can result from use with fluid that is too viscous or thick.

MAINTENANCE

CLEANING THE PUMPING CHAMBER

Debris such as weeds, sand and other solids may become trapped in the water hose and pumping chamber. This can reduce pump performance. It is important that the pumping chamber be kept clean at all times. The chamber can be cleaned as follows:

1. Remove motor and impeller by removing the seven 5/16–18 capscrews (item 14).
2. Thoroughly clean the volute and impeller. Do not remove the impeller unless necessary for repair or replacement or to remove trapped debris.
3. Remove all debris from the pump screen by removing the four 5/16–18 capscrews (item 18).
4. Assemble the motor and impeller to the volute. Clean the capscrews and lubricate the threads with underwater grease before installation.
5. Remove all debris from the hose. Otherwise, solids will backfill the pump.

TOOL PROTECTION & CARE

NOTICE

In addition to the safety precautions found in this manual, observe the following for equipment protection and care.

- Make sure all couplers are wiped clean before connection.
- The hydraulic circuit control valve must be in the “OFF” position when coupling or uncoupling hydraulic tools. Failure to do so may result in damage to the quick couplers and cause overheating of the hydraulic system.
- Always store the tool in a clean dry space, safe from damage or pilferage.
- Make sure the circuit PRESSURE hose (with male quick disconnect) is connected to the “IN” port. The circuit RETURN hose (with female quick disconnect) is connected to the opposite port. Do not reverse circuit flow. This can cause damage to internal seals.
- Always replace hoses, couplings and other parts with replacement parts recommended by STANLEY. Supply hoses must have a minimum working pressure rating of 2500 psi/172 bar.
- Do not exceed the rated flow or pressure. Refer to “Specifications” on page 14 for correct flow rate and pressure. If specifications are exceeded, rapid failure of the internal seals may result.
- Always keep critical tool markings, such as warning stickers and tags, legible.
- Do not use the tool for applications it was not designed for.
- Tool repair should be performed by experienced personnel only.
- Make certain that the recommended relief valves are installed in the pressure side of the system.
- Do not use the tool for applications for which it was not intended.

TROUBLESHOOTING

If symptoms of poor performance develop, the following chart can be used as a guide to correct the problem.

When diagnosing faults in operation, always make sure the hydraulic power source is supplying the correct hydraulic flow and pressure as listed in the table. Use a flowmeter known to be accurate. Check the flow with the hydraulic fluid temperature at least 80 °F/27 °C.

PROBLEM	CAUSE	SOLUTION
Pump will not start.	No hydraulic fluid flow or pressure.	Turn on power unit and check that 4–9 GPM/15–34 LPM at 1000–2000 psi/70–140 bar is available at the pump.
	Defective couplers.	Check the couplers. Replace if necessary.
	Impeller jammed with debris.	Clean the pumping chamber as described in “Maintenance” on page 11.
	Impeller rubbing against wear plates.	Check and adjust the impeller clearance as described in the Service Manual.
	Defective hydraulic motor.	Repair or replace motor.
Poor pump performance.	Hydraulic flow reversed.	Check that the hoses are correctly connected to the pump motor ports. The female coupler should be connected to the “IN” port. The return fluid must never flow through a reversing valve.
	Improper hydraulic fluid flow.	Check that 4–9 GPM/15–34 LPM at 1000–2000 psi/70–140 bar is available at the trash pump. A 20% decrease in flow can result in a 50% decrease in pump performance.
	Pump submersed in sediment.	Lift the pump from the bottom of the hole or chamber. Use a flat support under the pump if necessary.
	Trash pump inlet restricted.	Remove suction screen and thoroughly clean. Reassemble.
	Discharge hose kinked or restricted.	Straighten the hose. If the hose must bend at the top of the hole, use a piece of split rigid conduit with large diameter of the expanded hose. This keeps the hose from kinking.
	Discharge hose too small.	Use a 2-1/2 inch/63.5 mm diameter fire hose.
	Water lift too high.	Lower the outlet end of the discharge hose. Increase hydraulic flow (9 GPM/35 LPM max).
	Impeller worn or damaged.	Check impeller for damage and excessive wear. Replace if necessary.
	Pump not matched to application	Obtain higher capacity pump.
	Wear ring worn or damaged.	Check for wear ring damage or excessive wear. Replace if necessary.
	Hose used on suction side of pump.	Remove. Use no plumbing on suction side of pump.
Poor pump performance with excessive wear.	Too many solids in the water. Water speed out of the hose may be too slow, therefore hose and pump load up with solids.	Reduce solids content. Increase pump speed.

SPECIFICATIONS

Capacity.....	250 GPM/946 LPM
Weight	13.7 lbs/6.3 kg
Length.....	7.5 in./19 cm
Width	10 in./24 cm
Pressure	1000–2000 psi/70–140 bar
Flow Range	4–6 GPM/15–23 LPM (SM2052101)
Flow Range	7–9 GPM/26–34 LPM (SM2043101, SM2043107, SM2053101)
Porting	-8 SAE O-ring
Connect Size and Type	3/8 in. Flush Face Quick Disconnect Couplers
Discharge Diameter.....	2-1/2 in./6.3 cm

ACCESSORIES

Description	Part No.
Fire Hose, 25 ft × 2-1/2 in. Diameter Hose with 3 in. Threaded Male & Female Ends.....	02183
Fire Hose, 50 ft × 2-1/2 in. Diameter Hose with 3 in. Threaded Male & Female Ends.....	05134
Fire Nozzle, 1 in Outlet with 3 in. Threaded Female End.....	02317
Thread Adapter for Pump to Fire Hose, 2-1/2 in NPT Male End to Pump & 3 in Male Thread to Hose.	05133
Note: This Threaded Adapter is needed to connect pump to fire hose.	
Spanner Wrench for Pin Lug Coupler.....	05135
Lay Flat Hose with Couplers, 25 ft × 3 in. Diameter Camlock	56761
Adapter 2-1/2 NPT × 3 in. Camlock.....	59101

SM20 PARTS ILLUSTRATION

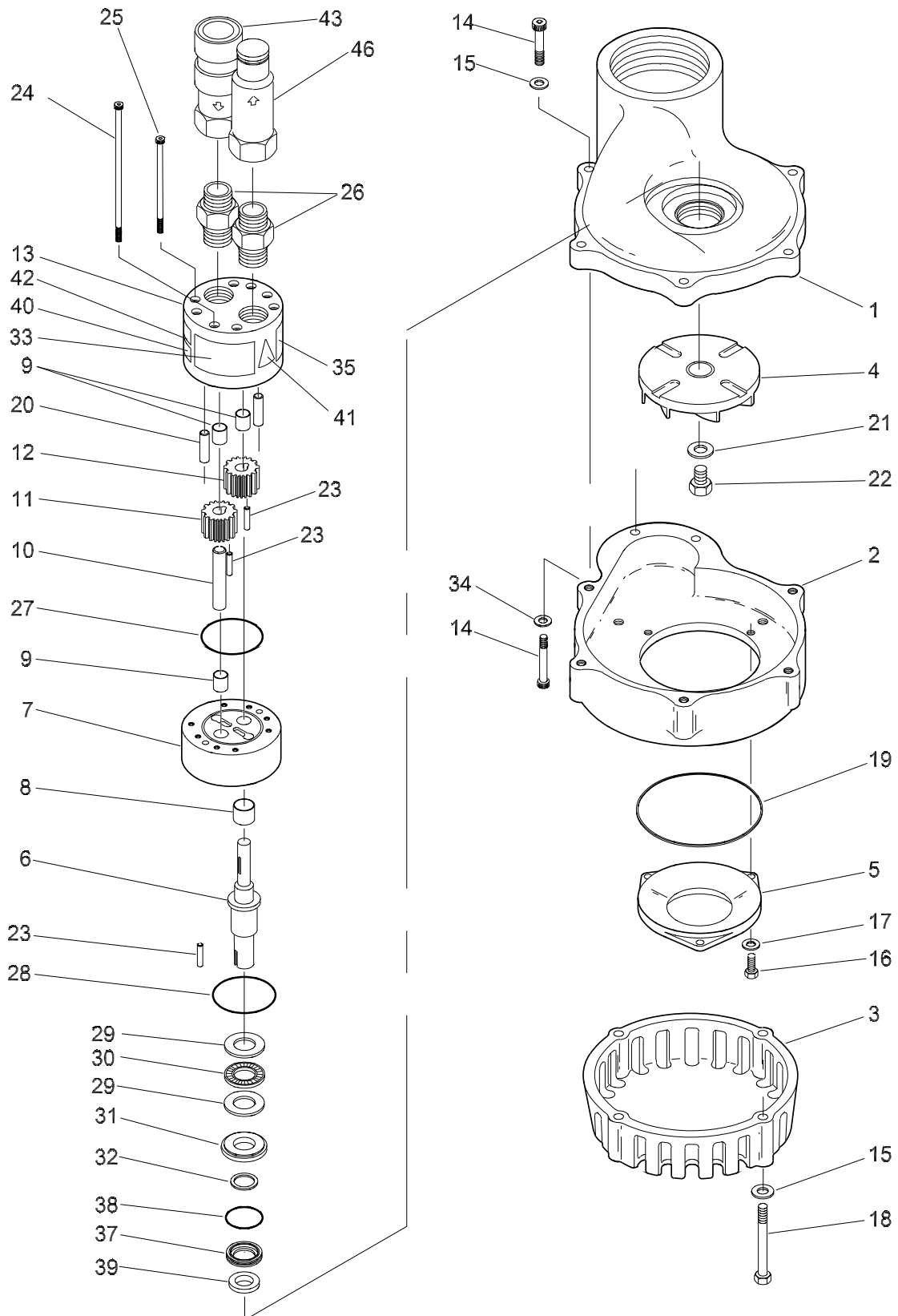

SM20 PARTS LIST

ITEM NO.	PART NO.	QTY	DESCRIPTION
1	19177	1	VOLUTE TOP
2	08910	1	VOLUTE BOTTOM
3	08912	1	SUCTION SCREEN
4	08914 25669	1 1	IMPELLER IMPELLER (SM2043101, SM2043107 ONLY)
5	08916	1	WEAR RING
6	19175 21120	1 1	MAIN SHAFT MAIN SHAFT (SM2052101 ONLY)
7A	08920	1	FRONT BEARING RETAINER ASSEMBLY (INCLUDES ITEMS 7-9)
7	08919	1	FRONT BEARING RETAINER
8	04040	1	DU BUSHING, 9/16 ID
9	04041	3	DU BUSHING, 3/8 ID
10	09382	1	IDLER SHAFT
11	09384 04106	1 1	DRIVE GEAR DRIVE GEAR (SM2052101 ONLY)
12	09384 04106	1 1	DRIVE GEAR DRIVE GEAR (SM2052101 ONLY)
13	09385 21121	1 1	GEAR HOUSING ASSEMBLY (INCLUDES ITEMS 9, 13, 20) GEAR HOUSING ASSY (INCL 9, 13, 20) (SM2052101 ONLY)
14	00230	7	CAPSCREW
15	00283	11	LOCKWASHER
16	08937	3	CAPSCREW
17	01324	3	LOCKWASHER
18	08925	4	CAPSCREW
19	08923	1	SHIMS, .020 (NOTE QUANTITY WHEN DISASSEMBLING TOOL)
20	00289	2	DOWEL PIN
21	02259	1	FLAT WASHER
22	01213	1	CAPSCREW
23	04044	3	NEEDLE ROLLER (1 FOR EACH GEAR) AND 1 FOR MOTOR SHAFT ON IMPELLER END.
24	08927 21128	4 4	CAPSCREW CAPSCREW (SM2052101 ONLY)
25	09687 00786	4 4	CAPSCREW CAPSCREW (SM2052101 ONLY)
26	00936	2	ADAPTER
27	00020	1	O-RING
28	00252	1	O-RING
29	06636	2	BEARING RACE
30	06637	1	THRUST BEARING
31	19178	1	BACKUP WASHER
32	30921	1	QUAD RING
33	74761 74762	1 1	SM20 MODEL DECAL 30 LPM SM20 MODEL DECAL 20 LPM (SM2052101 ONLY)
34	00283	2	LOCKWASHER

ITEM NO.	PART NO.	QTY	DESCRIPTION
35	28788	1	MANUAL DECAL
36	—	—	NO ITEM
37	71327	1	SEAL CARRIER
38	00074	1	O-RING
39	19176	1	WIPER SEAL
40	28323	1	CE DECAL (CE ONLY)
41	11207 11206	1	CIRCUIT TYPE D (CE ONLY) CIRCUIT TYPE C (CE ONLY) (SM2052101 ONLY)
42	28786	1	COUPLER DECAL
43	03972	1	FEMALE COUPLER
46	03973	1	MALE COUPLER
KT1	03971	1	COUPLER SET (INCLUDES ITEMS 43 & 46)
KT2	20135	1	REPAIR KIT (INCLUDES ITEMS 4, 21-23 & 29-31 PLUS SK1) NOTE THIS REPAIR KIT INCLUDES IMPELLER 08914 BUT NOT IMPELLER 25669)
SK1	19937	1	SEAL KIT (INCLUDES ITEMS 27, 28, 32, 37-39)

UNDERWATER TOOLS DEPTH GUIDELINE

UNDERWATER MODELS ONLY

⚠ CAUTION

Do not use hydraulic tools underwater that are not designated as an “underwater” model, or this will result in damage to the tool.

For underwater hydraulic tools the applications are broken down into four quadrants depending on type of tool and method of operation.

The types of tools are percussive and rotational, each with different characteristics allowing for different depth operation. With percussive tools, the nitrogen accumulator PSI must counter the increase in ambient pressure found at lower depths. Since there is a maximum PSI for percussive tools they are limited to certain depths. Rotational tools do not have accumulators and thus are capable of deeper depths.

The methods are broken into diver operated or remote operated vehicle (ROV). ROV's can reach lower depths and with an onboard hydraulic power source that is depth compensated, can operate hydraulic tools at depths of thousands of feet. ROV operation is still limited to the tool, for example a percussive tool has the same depth limitation whether ROV or diver operated.



OPERATION OVERVIEW

	PERCUSSIVE	ROTATIONAL
DIVER	Tools: Breakers, Hammer Drills and Chipping Hammers Max Depth: 500' - limitations due to accumulator PSI max (increase 40 PSI for every 100')	Tools: Grinders, Saws, Chain Saws Max Depth: 1000' - Reference hose sizing guide below
ROV	Tools: Breakers, Hammer Drills and Chipping Hammers Max Depth: 500' - limitations due to accumulator PSI max (increase 40 PSI for every 100')	Tools: Grinders, Saws, Chain Saws Max Depth: 1000' - Reference hose sizing guide below

RECOMMENDED HOSE DIAMETERS

DEPTH (FT)	8 GPM	12 GPM
100	5/8"	5/8"
300	3/4"	1"
600	1"	1"
1000	1"	1-1/4"



STANLEY®

STANLEY Infrastructure
6430 SE Lake Road
Portland, Oregon 97222 USA
(503) 659-5660 / Fax (503) 652-1780
www.stanleyinfrastructure.com