

STANLEY®

CT04 HYDRAULIC CRIMPING TOOL



USER MANUAL Safety, Operation and Maintenance



© 2014 Stanley Black & Decker, Inc.
New Britain, CT 06053
U.S.A.
58541 10-2014 Ver. 4

TABLE OF CONTENTS

WARRANTY (SEE BELOW UNDER "IMPORTANT")	3
SAFETY SYMBOLS	4
SAFETY PRECAUTIONS	5
TOOL STICKERS AND TAGS	6
HOSE TYPES	7
HOSE RECOMMENDATIONS	8
HTMA REQUIREMENTS	9
OPERATION	10
SETUP AND TEST	10
OPEN CENTER/CLOSED CENTER SETUP	10
DIE INSTALLATION	10
TOOL PROTECTION & CARE	14
TROUBLESHOOTING	15
SPECIFICATIONS	16
CT04 ILLUSTRATION	17
CT04 PARTS LIST	18

IMPORTANT

To fill out a Product Warranty Validation form, and for information on your warranty, visit Stanleyhydraulics.com and select the Company tab, Warranty.
(NOTE: The warranty Validation record must be submitted to validate the warranty).

SERVICING: This manual contains safety, operation, and routine maintenance instructions. Stanley Hydraulic Tools recommends that servicing of hydraulic tools, other than routine maintenance, must be performed by an authorized and certified dealer. Please read the following warning.

⚠ WARNING

SERIOUS INJURY OR DEATH COULD RESULT FROM THE IMPROPER REPAIR OR SERVICE OF THIS TOOL.

REPAIRS AND / OR SERVICE TO THIS TOOL MUST ONLY BE DONE BY AN AUTHORIZED AND CERTIFIED DEALER.

For the nearest authorized and certified dealer, call Stanley Hydraulic Tools at the number listed on the back of this manual and ask for a Customer Service Representative.

SAFETY SYMBOLS

Safety symbols and signal words, as shown below, are used to emphasize all operator, maintenance and repair actions which, if not strictly followed, could result in a life-threatening situation, bodily injury or damage to equipment.



This is the safety alert symbol. It is used to alert you to potential personal injury hazards. Obey all safety messages that follow this symbol to avoid possible injury or death.



This safety alert and signal word indicate an imminently hazardous situation which, if not avoided, will result in death or serious injury.



This safety alert and signal word indicate a potentially hazardous situation which, if not avoided, could result in death or serious injury.



This safety alert and signal word indicate a potentially hazardous situation which, if not avoided, could result in death or serious injury.



This signal word indicates a potentially hazardous situation which, if not avoided, may result in property damage.



This signal word indicates a situation which, if not avoided, will result in damage to the equipment.

This signal word indicates a situation which, if not avoided, may result in damage to the equipment.

Always observe safety symbols. They are included for your safety and for the protection of the tool.

LOCAL SAFETY REGULATIONS

Enter any local safety regulations here. Keep these instructions in an area accessible to the operator and maintenance personnel.

SAFETY PRECAUTIONS

Tool operators and maintenance personnel must always comply with the safety precautions given in this manual and on the stickers and tags attached to the tool and hose.

These safety precautions are given for your safety. Review them carefully before operating the tool and before performing general maintenance or repairs.





Supervising personnel should develop additional precautions relating to the specific work area and local safety regulations. If so, place the added precautions in the space provided in this manual.

The model CT04 Hydraulic Crimping Tool will provide safe and dependable service if operated in accordance with the instructions given in this manual. Read and understand this manual and any stickers and tags attached to the tool and hose before operation. Failure to do so could result in personal injury or equipment damage.



- The operator must start in a work area without bystanders. Flying debris can cause serious injury.
- Make sure all critical tool markings, such as labels and warning decals, are securely in place and legible. Replace any that are damaged or missing.
- Do not operate the tool unless thoroughly trained or under the supervision of an instructor. Establish a training program for all operators to ensure safe operation.
- Always wear personal protection equipment (PPE) such as goggles, ear and head protection, and safety shoes at all times when operating the tool. Use gloves and aprons when necessary.
- Never wear loose clothing or unrestrained long hair that can get entangled in the working parts of the tool.
- Keep all parts of your body away from the tool and maintain proper footing and balance at all times.
- Do not rely exclusively upon the safety devices built into the tool.
- Always be well rested and mentally alert before operating the tool.
- The operator must be familiar with all prohibited work areas such as excessive slopes and dangerous terrain conditions.
- Know the location of buried or covered electrical services before starting work.
- Keep your work area clean and clear of tripping hazards. Oily surfaces and hoses lying around can be hazardous.
- Always operate the tool within its rated capacity.
- Do not use the tool for applications for which it was not designed.
- Do not inspect, clean or replace any part(s) if the hydraulic power source is connected. Do not inspect or clean the tool while the hydraulic power source is connected. Accidental engagement of the tool can cause serious injury.
- Always connect hoses to the tool hose couplers before energizing the hydraulic power source. Be sure all hose connections are tight and are in good condition.
- Always replace hoses, couplings, and other parts with replacement parts recommended by Stanley Hydraulic Tools. Refer to the parts list at the end of this manual for part numbers.
- Do not operate the tool at oil temperatures above 140 °F/60 °C. Operation at higher temperatures can cause higher than normal temperatures at the tool which can result in operator discomfort.
- Do not operate a damaged, improperly adjusted, or incompletely assembled tool. Do not carry tool by the hoses.
- Keep the handles dry, clean and free of oil.
- Ensure adequate lighting for the area where the tool is being used.
- Use proper lifting techniques when handling the tool. Do not overreach. Maintain secure footing and balance at all times.
- When using tools near energized transmission lines, be sure to use only hoses labeled and certified non-conductive.
- Turn off the power unit or move the hydraulic control valve to neutral before setting the tool down.
- To avoid personal injury or equipment damage, all tool repair, maintenance and service must only be performed by authorized and properly trained personnel.

TOOL STICKERS & TAGS

 Stanley Hydraulic Tools 3810 SE Naef Road Milwaukee, OR 97267	
Model No. CT04	11-24 (p/n) 0 gpm 138 bar (2000 psi)
<p>OC/CC</p> For use on open center and closed center hydraulic systems. Use open center tool on open center systems. Use closed center tool on closed center systems. Set tool for proper system before use.	
<p>CAUTION</p> DO NOT OPERATE WITHOUT DIES	
WARNING	
	Read owners manual and make sure that you have been properly trained in the correct procedures required for work. On or around electric lines. Failure to use hydraulic hose labeled and certified as non-conductive when using hydraulic tools on or near electric lines may result in death or serious injury.
	Do not exceed specified flow or pressure. Correctly connect hoses to tool "IN" and "OUT." Improper handling, use or maintenance can result in a leak or burst. Contact at a leak or burst can cause oil injection to the body. Failure to observe the precautions can result in serious personal injury.
	Stay clear of dies and tool heads. Failure to observe the precautions can result in serious personal injury.

58501
CT04 1650 psi Combined Sticker

**DO NOT OPERATE
WITHOUT DIES**

07961
Warning Sticker

NOTE:

THE INFORMATION LISTED ON THE STICKERS SHOWN, MUST BE LEGIBLE AT ALL TIMES.

REPLACE DECALS IF THEY BECOME WORN OR DAMAGED. REPLACEMENTS ARE AVAILABLE FROM YOUR LOCAL STANLEY DISTRIBUTOR.

The safety tag (P/N 15875) at right is attached to the tool when shipped from the factory. Read and understand the safety instructions listed on this tag before removal. We suggest you retain this tag and attach it to the tool when not in use.

DANGER

1. FAILURE TO USE HYDRAULIC HOSE LABELED AND CERTIFIED AS NON-CONDUCTIVE WHEN USING HYDRAULIC TOOLS ON OR NEAR ELECTRICAL LINES MAY RESULT IN DEATH OR SERIOUS INJURY.
BEFORE USING HOSE LABELED AND CERTIFIED AS NON-CONDUCTIVE ON OR NEAR ELECTRICAL LINES BE SURE THE HOSE IS MAINTAINED AS NON-CONDUCTIVE. THE HOSE SHOULD BE REGULARLY TESTED FOR ELECTRIC CURRENT LEAKAGE IN ACCORDANCE WITH YOUR SAFETY DEPARTMENT INSTRUCTIONS.
2. A HYDRAULIC LEAK OR BURST MAY CAUSE OIL INJECTION INTO THE BODY OR CAUSE OTHER SEVERE PERSONAL INJURY.
 - A. **DO NOT EXCEED SPECIFIED FLOW AND PRESSURE** FOR THIS TOOL. EXCESS FLOW OR PRESSURE MAY CAUSE A LEAK OR BURST.
 - B. **DO NOT EXCEED RATED WORKING PRESSURE** OF HYDRAULIC HOSE USED WITH THIS TOOL. EXCESS PRESSURE MAY CAUSE A LEAK OR BURST.
 - C. CHECK TOOL HOSE COUPLERS AND CONNECTORS DAILY FOR LEAKS. **DO NOT FEEL** FOR LEAKS WITH YOUR HANDS. CONTACT WITH A LEAK MAY RESULT IN SEVERE PERSONAL INJURY.

IMPORTANT

READ OPERATION MANUAL AND SAFETY INSTRUCTIONS FOR THIS TOOL BEFORE USING IT.

USE ONLY PARTS AND REPAIR PROCEDURES APPROVED BY STANLEY AND DESCRIBED IN THE OPERATION MANUAL.

TAG TO BE REMOVED ONLY BY TOOL OPERATOR.

SEE OTHER SIDE

DANGER

- D. DO NOT LIFT OR CARRY TOOL BY THE HOSES. DO NOT ABUSE HOSE. DO NOT USE KINKED, TORN OR DAMAGED HOSE.
3. MAKE SURE HYDRAULIC HOSES ARE PROPERLY CONNECTED TO THE TOOL BEFORE PRESSURING SYSTEM. SYSTEM PRESSURE HOSE MUST ALWAYS BE CONNECTED TO TOOL "IN" PORT. SYSTEM RETURN HOSE MUST ALWAYS BE CONNECTED TO TOOL "OUT" PORT. REVERSING CONNECTIONS MAY CAUSE REVERSE TOOL OPERATION WHICH CAN RESULT IN SEVERE PERSONAL INJURY.
4. DO NOT CONNECT OPEN-CENTER TOOLS TO CLOSED-CENTER HYDRAULIC SYSTEMS. THIS MAY RESULT IN LOSS OF OTHER HYDRAULIC FUNCTIONS POWERED BY THE SAME SYSTEM AND/OR SEVERE PERSONAL INJURY.
5. BYSTANDERS MAY BE INJURED IN YOUR WORK AREA. KEEP BYSTANDERS CLEAR OF YOUR WORK AREA.
6. WEAR HEARING, EYE, FOOT, HAND AND HEAD PROTECTION.
7. TO AVOID PERSONAL INJURY OR EQUIPMENT DAMAGE, ALL TOOL REPAIR MAINTENANCE AND SERVICE MUST ONLY BE PERFORMED BY AUTHORIZED AND PROPERLY TRAINED PERSONNEL.

IMPORTANT

READ OPERATION MANUAL AND SAFETY INSTRUCTIONS FOR THIS TOOL BEFORE USING IT.

USE ONLY PARTS AND REPAIR PROCEDURES APPROVED BY STANLEY AND DESCRIBED IN THE OPERATION MANUAL.

TAG TO BE REMOVED ONLY BY TOOL OPERATOR.

SEE OTHER SIDE

SAFETY TAG P/N 15875 (Shown smaller than actual size)

HOSE TYPES

The rated working pressure of the hydraulic hose must be equal to or higher than the relief valve setting on the hydraulic system. There are three types of hydraulic hose that meet this requirement and are authorized for use with Stanley Hydraulic Tools. They are:

Certified non-conductive — constructed of thermoplastic or synthetic rubber inner tube, synthetic fiber braid reinforcement, and weather resistant thermoplastic or synthetic rubber cover. *Hose labeled **certified non-conductive** is the only hose authorized for use near electrical conductors.*

Wire-braided (conductive) — constructed of synthetic rubber inner tube, single or double wire braid reinforcement, and weather resistant synthetic rubber cover. *This hose is **conductive** and must never be used near electrical conductors.*

Fabric-braided (not certified or labeled non-conductive) — constructed of thermoplastic or synthetic rubber inner tube, synthetic fiber braid reinforcement, and weather resistant thermoplastic or synthetic rubber cover. *This hose is **not certified non-conductive** and must never be used near electrical conductors.*

HOSE SAFETY TAGS

To help ensure your safety, the following DANGER tags are attached to all hose purchased from Stanley Hydraulic Tools. **DO NOT REMOVE THESE TAGS.**

If the information on a tag is illegible because of wear or damage, replace the tag immediately. A new tag may be obtained from your Stanley Distributor.

THE TAG SHOWN BELOW IS ATTACHED TO “CERTIFIED NON-CONDUCTIVE” HOSE

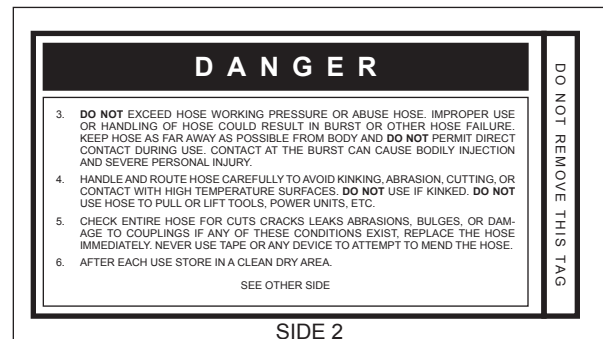
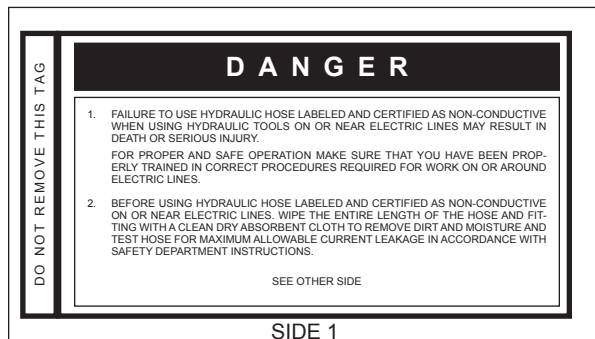

(Shown smaller than actual size)

THE TAG SHOWN BELOW IS ATTACHED TO “CONDUCTIVE” HOSE.

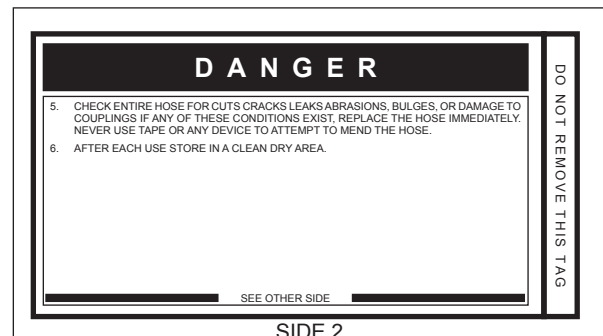
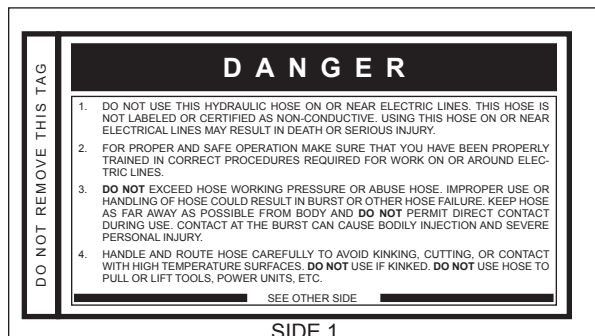

(Shown smaller than actual size)

HOSE RECOMMENDATIONS

Tool to Hydraulic Circuit Hose Recommendations

The chart to the right shows recommended minimum hose diameters for various hose lengths based on gallons per minute (gpm)/liters per minute (lpm). These recommendations are intended to keep return line pressure (back pressure) to a minimum acceptable level to ensure maximum tool performance.

This chart is intended to be used for hydraulic tool applications only based on Stanley Hydraulic Tools tool operating requirements and should not be used for any other applications.

All hydraulic hose must have at least a rated minimum working pressure equal to the maximum hydraulic system relief valve setting.

All hydraulic hose must meet or exceed specifications as set forth by SAE J517.

Oil Flow		Hose Lengths		Inside Diameter		USE (Press/Return)	Min. Working Pressure	
GPM	LPM	FEET	METERS	INCH	MM		PSI	BAR
Certified Non-Conductive Hose - Fiber Braid - for Utility Bucket Trucks								
4-9	15-34	up to 10	up to 3	3/8	10	Both	2250	155
Conductive Hose - Wire Braid or Fiber Braid -DO NOT USE NEAR ELECTRICAL CONDUCTORS								
4-6	15-23	up to 25	up to 7.5	3/8	10	Both	2500	175
4-6	15-23	26-100	7.5-30	1/2	13	Both	2500	175
5-10.5	19-40	up to 50	up to 15	1/2	13	Both	2500	175
5-10.5	19-40	51-100	15-30	5/8	16	Both	2500	175
5-10.5	19-40	100-300	30-90	5/8	16	Pressure	2500	175
10-13	38-49	up to 50	up to 15	3/4	19	Return	2500	175
10-13	38-49	51-100	15-30	5/8	16	Both	2500	175
10-13	38-49	100-200	30-60	3/4	19	Pressure	2500	175
13-16	49-60	up to 25	up to 8	5/8	16	Return	2500	175
13-16	49-60	26-100	8-30	3/4	19	Return	2500	175
				1	25.4	Return	2500	175
				5/8	16	Pressure	2500	175
				3/4	19	Return	2500	175
				3/4	19	Pressure	2500	175
				1	25.4	Return	2500	175

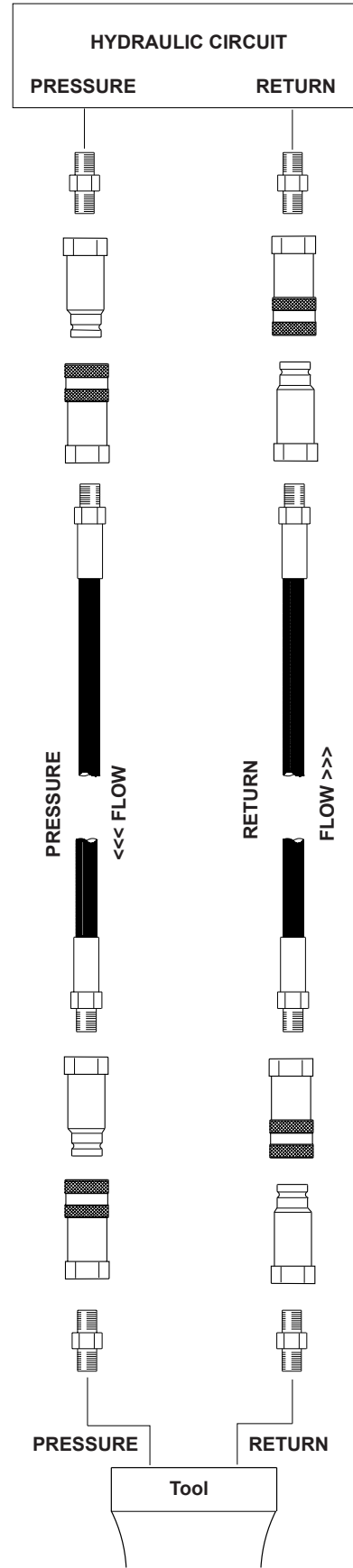

Figure 1. Typical Hose Connections

HTMA / EHTMA REQUIREMENTS

HTMA

HYDRAULIC SYSTEM REQUIREMENTS

TOOL TYPE

TYPE I

TYPE II

TYPE RR

TYPE III

Flow Range	4-6 gpm (15-23 lpm)	7-9 gpm (26-34 lpm)	9-10.5 gpm (34-40 lpm)	11-13 gpm (42-49 lpm)
Nominal Operating Pressure (at the power supply outlet)	1500 psi (103 bar)	1500 psi (103 bar)	1500 psi (103 bar)	1500 psi (103 bar)
System relief valve setting (at the power supply outlet)	2100-2250 psi (145-155 bar)	2100-2250 psi (145-155 bar)	2200-2300 psi (152-159 bar)	2100-2250 psi (145-155 bar)
Maximum back pressure (at tool end of the return hose)	250 psi (17 bar)	250 psi (17 bar)	250 psi (17 bar)	250 psi (17 bar)
Measured at a max. fluid viscosity of: (at min. operating temperature)	400 ssu* (82 centistokes)	400 ssu* (82 centistokes)	400 ssu* (82 centistokes)	400 ssu* (82 centistokes)
Temperature: Sufficient heat rejection capacity to limit max. fluid temperature to: (at max. expected ambient temperature)	140° F (60° C)	140° F (60° C)	140° F (60° C)	140° F (60° C)
Min. cooling capacity at a temperature difference of between ambient and fluid temps	3 hp (2.24 kW) 40° F (22° C)	5 hp (3.73 kW) 40° F (22° C)	6 hp (5.22 kW) 40° F (22° C)	7 hp (4.47 kW) 40° F (22° C)
NOTE: Do not operate the tool at oil temperatures above 140° F (60° C). Operation at higher temperatures can cause operator discomfort at the tool.				
Filter Min. full-flow filtration Sized for flow of at least: (For cold temp. startup and max. dirt-holding capacity)	25 microns 30 gpm (114 lpm)	25 microns 30 gpm (114 lpm)	25 microns 30 gpm (114 lpm)	25 microns 30 gpm (114 lpm)
Hydraulic fluid Petroleum based (premium grade, anti-wear, non-conductive) Viscosity (at min. and max. operating temps)	100-400 ssu*	100-400 ssu* (20-82 centistokes)	100-400 ssu*	100-400 ssu*
NOTE: When choosing hydraulic fluid, the expected oil temperature extremes that will be experienced in service determine the most suitable temperature viscosity characteristics. Hydraulic fluids with a viscosity index over 140 will meet the requirements over a wide range of operating temperatures.				
*SSU = Saybolt Seconds Universal				

EHTMA HYDRAULIC SYSTEM REQUIREMENTS

CLASSIFICATION



Flow Range	3.5-4.3 gpm (13.5-16.5 lpm)	4.7-5.8 gpm (18-22 lpm)	7.1-8.7 gpm (27-33 lpm)	9.5-11.6 gpm (36-44 lpm)	11.8-14.5 gpm (45-55 lpm)
Nominal Operating Pressure (at the power supply outlet)	1870 psi (129 bar)	1500 psi (103 bar)	1500 psi (103 bar)	1500 psi (103 bar)	1500 psi (103 bar)
System relief valve setting (at the power supply outlet)	2495 psi (172 bar)	2000 psi (138 bar)	2000 psi (138 bar)	2000 psi (138 bar)	2000 psi (138 bar)

NOTE: These are general hydraulic system requirements. See tool specification page for tool specific requirements

OPERATION

PRE-OPERATION

Careful inspection of the tool and hydraulic system before startup is important for safe, reliable operation of the tool.

The following items should be checked daily at the start and the end of each work shift.

1. Make sure the proper dies are securely in place. Operating the tool without dies can deform the crimping heads. Refer to Die Installation for instructions.
2. Connect hoses. Wipe all hose couplers with a clean, lint-free cloth before making connections. Dirty couplers can contaminate the hydraulic lines and prevent a good seal at the connection.
3. Check all fasteners for tightness.
4. Check the equipment for oil leaks. If leaks are observed, do not use the tool; have the equipment serviced before use.
5. Check the tool and hydraulic system for proper operation and performance.
6. If the equipment does not appear to operate properly, have it serviced before use.
7. Periodically verify the crimping force of the tool. Refer to Die Load Verification.

SETUP AND TEST

- Never operate the tool without dies. Operating without dies can deform the crimping head (retainer die yoke or C-frame).
- If this happens, the dies cannot be installed and the crimping head must be replaced.
- Never install the dies while the hydraulic hoses are connected to the tool.
- Verify the crimping force before operating the tool.

OPEN CENTER/CLOSED CENTER SETUP

The CT04 Hydraulic Crimping Tool can be configured for either open-center or closed-center operation. The current setting is easily determined by looking at the gap between the adapter and the cylinder:

TO CHANGE THE CURRENT SETTING:

1. Remove the hydraulic hose coupling from the return port on the tool, if one is installed. When making the change from CC to OC, hydraulic fluid may be trapped in the tool, preventing complete movement of the adapter. Remove the return coupling to allow the hydraulic fluid to escape.

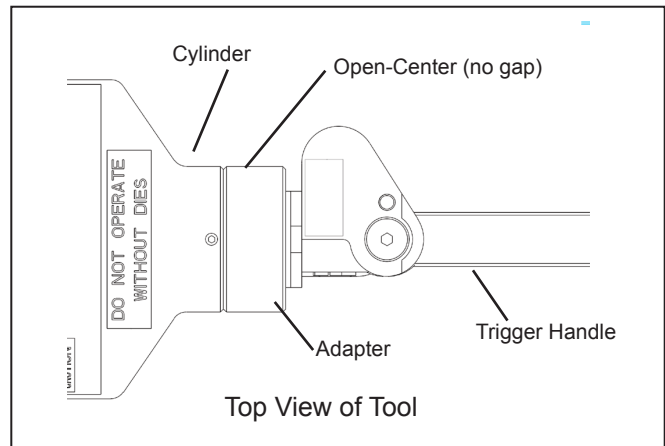

2. Loosen the 2 setscrews on the cylinder.
3. Turn the adapter until it stops:
 - Counter Clockwise (CCW) to change to closed center (creates gap)
 - Clockwise (CW) to change to open center (closes gap)
4. Tighten the two setscrews.

DIE INSTALLATION

Each crimping head has two die holders: one stationary and one moved by hydraulic flow when the trigger is squeezed.

To install dies, follow the instructions below for your model of crimping head.

⚠ WARNING

Installing dies in the tools with the hydraulic hoses connected can cause severe personal injury or equipment damage.

To prevent accidental start-up, always disconnect the hoses before installing dies.

1. If the hydraulic hoses are connected:
 - Turn the hydraulic system control valve OFF.
 - Disconnect first the hydraulic input (supply) hose, then the output (return) hose.
2. Clean the surfaces of the die holder to remove any dirt or grease.
3. Select the dies for the task:
 - If the die load *has not* been verified, select blank dies and verify die load.

OPERATION

- If the die load *has* been verified, select a set of dies to match the sleeve or connector to be crimped.

TO INSTALL DIES ON KEARNEY “O” STYLE HEAD

1. Loosen the two die retainer screws (items ___ on the parts illustration).
2. Insert and center the dies.
3. Tighten the die retainer screws to lock the dies in place.

TO INSTALL DIES ON BURNDY “W” STYLE HEAD

1. Squeeze the release buttons on the side of the C-head.
2. Insert and center the die.
3. Release the buttons to hold the die in place.
4. Repeat above steps 1 through 3 above using the release buttons on the piston die holder.

HYDRAULIC HOSE CONNECTION

Make sure the hydraulic system control valve is in the OFF position when coupling or uncoupling the hoses. Failure to do so may result in damage to the quick couplers and cause overheating of the hydraulic system.

Before installing the hoses, wipe the fittings and the entire length of the hoses with a clean, dry lint-free cloth to remove any dirt or moisture. Dirty connections can contaminate the hydraulic fluid, causing rapid wear and early failure of internal parts.

Check the flow indicators (arrows) stamped on the couplers to ensure oil flows in the proper direction. The female coupler on the tool is the inlet coupler.

It is a good practice to connect the output (return) hose first and disconnect it last to minimize or avoid trapped pressure within the tool.

1. Connect the output hose to the OUT or T port on the tool.
2. Connect the input hose to the IN or P port.
3. Be sure all hose connections are tight.

DIE LOAD VERIFICATION

With blank (test) dies installed, use a die load tester to verify the crimping force in the tool before operating a new crimping tool, before placing the tool in service after storage or repair or periodically during normal use

1. Make sure blank (test) dies are installed in the die holder. If not, follow the Die Installation instructions at the beginning of this section.
2. Connect the tool to an appropriate hydraulic power source. Follow the Hydraulic Hose Connection safety guidelines and instructions in this section. If possible, use the hydraulic power source you plan to use for crimping.
3. Place the die load tester between the blank (test) dies.
4. Actuate the tool and read the value shown on the load tester indicator. The force should be 4.4–5 tons (4000–4540 kg), depending on the pressure from the hydraulic power source.
 - a. If the indicated value is low and the system pressure relief valve setting is greater than 1650 psi (114 bar), adjust the relief valve on the CT to get the correct die load.
 - b. If the indicated value is high, adjust the relief valve on the CT to get the correct die load.
5. When the value is within the acceptable range, turn the hydraulic system control valve OFF and disconnect the hoses from the tool.
6. Follow the Die Installation instructions at the beginning of this section to remove the blank dies and install the proper crimping dies.

OC/CC SETTING

Check the open-center/closed-center (OC/CC) setting on the tool. The current setting is easily determined by looking at the gap between the adapter and the cylinder, see Figure 5-1.

- Open Center: No gap
- Closed Center: Approximately 1/4-inch (6.4-mm) gap

If the setting is not correct for your hydraulic system, follow the instructions in this section, OC/CC Adjustment, to make the change.

DIE CHECK

Make sure the dies installed in the tool match the sleeve or connector to be crimped. If not, follow the instructions in this section, Die Installation.

CHECK POWER SOURCE

Using a calibrated flowmeter and pressure gauge, check the hydraulic power source at the tool's input port. Make sure the system maintains an operating flow in the range of 3–9 gpm/11–34 lpm within a pressure range of 1650–2000 psi /114–140 bar.

OPERATION

The hydraulic fluid temperature should be at least 80 °F/27 °C for this test.

CONNECT HOSES

1. Wipe all hose couplers with a clean, lint-free cloth before making connections.
2. Connect hoses from the hydraulic power source to the tool fittings or quick disconnects. It is good practice to connect the return hose first and disconnect it last to minimize or eliminate trapped pressure within the wrench.
3. Observe the flow indicators stamped on the main body assembly and the hose couplers to ensure that the flow is in the proper directions. The female couple on the tools "IN" port is the inlet (pressure) coupler.

NOTE:

If the uncoupled hoses are left in the sun, pressure increase within the hoses can make them difficult to connect. Whenever possible, connect the free ends of the hoses together.

TOOL RELIEF VALVE ADJUSTMENT

The relief valve on a universal pressure CT can be adjusted to increase or decrease the tool's crimping force. Standard CT's do not have a relief valve.

The crimping tools relief valve is located below the trigger guard. The relief valve on the hydraulic system is totally separate and has a different function.

1. Perform steps 1 through 5 under Die Load Verification.
2. If the load tester indication is within the acceptable range, the tools' relief valve on the hydraulic system is set correctly. If it is not, adjust the valve as follows:
 - a. Turn the hydraulic system control valve OFF.
 - b. Remove the plug from the end of the relief valve, below the trigger guard.
 - c. Using a hex wrench, turn the adjusting screw. Clockwise (CW) to increase pressure or Counterclockwise (CCW) to decrease pressure.
 - d. Replace the plug in the relief valve and retest. Repeat the adjustment if necessary.

OPERATION

Observe all safety precautions when operating the tool. Read Safety and Hydraulic System Requirements, before operating the tool for the first time.

CONDUCTOR PREPARATION

1. If the conductor is insulated, remove the insulation from the end of the conductor.

Use an insulation stripping tool. If a stripping tool is not available, carefully shave the insulation from the cable.

Be sure not to nick or cut the strands of the conductor.

2. Remove any oxide or foreign matter from the exposed conductor. A bright, shiny surface is required for a good connection. Do not wire-brush tin-plated copper conductors or tinned connectors.

STARTUP

1. Move the hydraulic system control valve to the ON position.
2. Remove any trapped air from the tool by squeezing the trigger 4 or 5 times to advance and retract the piston nearly a full stroke.
3. Position the tool to make the crimp.

IMPORTANT

Failure to center the connector between the dies will damage the dies and/or die holders.

4. Hook the stationary (C-Head) die on the connector being crimped to ensure the connector is centered between the dies.
5. Squeeze the trigger to advance the piston and crimp the connector.
6. Release the trigger to retract the piston.
7. Slide the tool into position for the next crimp. Some sleeves and connectors have special crimping requirements. Refer to the fitting manufacturer's requirements.
8. Remove the tool by lifting it free of the connector.

OPERATION

SHUTDOWN

1. Move the hydraulic system control valve to the OFF position.
2. Disconnect the hydraulic hoses from the tool - first the input (supply) hose, then the output (return) hose.
3. Insert plugs in the hose ends, couplers or tool ports, as applicable.
4. Wipe the tool thoroughly with a clean dry cloth.
5. Clean any foreign matter or joint compound from the die holder surfaces.

COLD WEATHER OPERATION

If the tool is to be used during cold weather, preheat the hydraulic fluid at low engine speed. When using the normally recommended fluids, fluid temperature should be at or above 50 °F/10 °C (400 ssu/82 centistokes) before use.

Damage to the hydraulic system or compression tool can result from use with fluid that is too viscous or too thick.

STORAGE

Replace any damaged or missing safety labels and tags before storing the tool. Clean, dry and lubricate moving parts before storage. Store in a clean, dry place.

TOOL PROTECTION & CARE

NOTICE

In addition to the Safety Precautions found in this manual, observe the following for equipment protection and care.

- Make sure all couplers are wiped clean before connection.
- The hydraulic circuit control valve must be in the “OFF” position when coupling or uncoupling hydraulic tools. Failure to do so may result in damage to the quick couplers and cause overheating of the hydraulic system.
- Always store the tool in a clean dry space, safe from damage or pilferage.
- Make sure the circuit PRESSURE hose (with male quick disconnect) is connected to the “IN” port. The circuit RETURN hose (with female quick disconnect) is connected to the opposite port. Do not reverse circuit flow. This can cause damage to internal seals.
- Always replace hoses, couplings and other parts with replacement parts recommended by Stanley Hydraulic Tools. Supply hoses must have a minimum working pressure rating of 2500 psi/172 bar.
- Do not exceed the rated flow. Refer to Specifications in this manual for correct flow rate. Rapid failure of the internal seals may result.
- Always keep critical tool markings, such as warning stickers and tags legible.
- Do not force a small tool to do the job of a large tool.
- Tool repair should be performed by experienced personnel only.
- Make certain that the recommended relief valves are installed in the pressure side of the system.
- Do not use the tool for applications for which it was not intended.

TROUBLESHOOTING

If symptoms of poor performance develop, the following chart can be used as a guide to correct the problem.

When diagnosing faults in operation of the grinder, always check that the hydraulic power source is supplying the correct hydraulic flow and pressure to the grinder as listed in the table. Use a flowmeter known to be accurate. Check the flow with the hydraulic oil temperature at least 80°F/27°C.

PROBLEM	CAUSE	SOLUTION
Tool does not operate.	Hydraulic hoses not connected properly.	Make sure hoses are connected and the couplers are tight.
	Hydraulic control valve OFF.	Turn the hydraulic system control valve ON.
	Hydraulic system not functioning.	Check hydraulic power unit for correct flow and pressure.
	Couplers or hoses blocked.	Remove obstruction.
	Pressure port check valve is installed in tool return port.	Install pressure port check valve in pressure port.
Tool operates in reverse (piston advances/retracts when trigger is squeezed).	Hoses connected to wrong ports on tool.	Connect input (supply) line to IN port. Connect output (return) line to OUT port.
Tool under-crimps. Die load less than 4.4 tons/4000 kg.	Hydraulic system pressure too low.	Check hydraulic power source for correct flow and pressure.
	Relief valve set too low.	Increase relief valve pressure.
	Dirt or obstruction between dies.	Remove obstruction. Clean die area.
	Piston seal worn or damaged.	Contact an authorized Stanley distributor.
	Improper die set for wire and connector.	Install proper die set.
Tool over-crimps. Die load more than 5 tons/4540 kg.	Hydraulic system pressure too high.	Check hydraulic power source for correct flow and pressure.
	Relief valve set too high.	Decrease relief valve pressure.
Trigger difficult to operate.	Hoses connected to wrong ports on tool.	Connect input (supply) line to IN port. Connect output (return) line to OUT port.
	Excessive back-pressure.	If back-pressure is greater than 250 psi/17 bar, clear the return line obstruction or restriction.
	Trigger guard bent and binding on spool in bore.	Repair or replace trigger assembly.

SPECIFICATIONS

Capacity	#6 - 4/0 Conductor
Crimping Force	4.4 tons @ 1650 psi / 4000 kg @ 114 bar
Pressure Range	1650 psi/114 bar
Flow Range	3-9 gpm / 11-34 lpm
Optimum Flow	8 gpm / 30 lpm
Porting	3/8 NPT
Hose Whips & Couplers	No
Weight	12 lbs / 5.4 kg
Overall Length	20 inches / 50.8 cm
Overall Width	3.75 inches / 9.5 cm

CT04 ILLUSTRATION

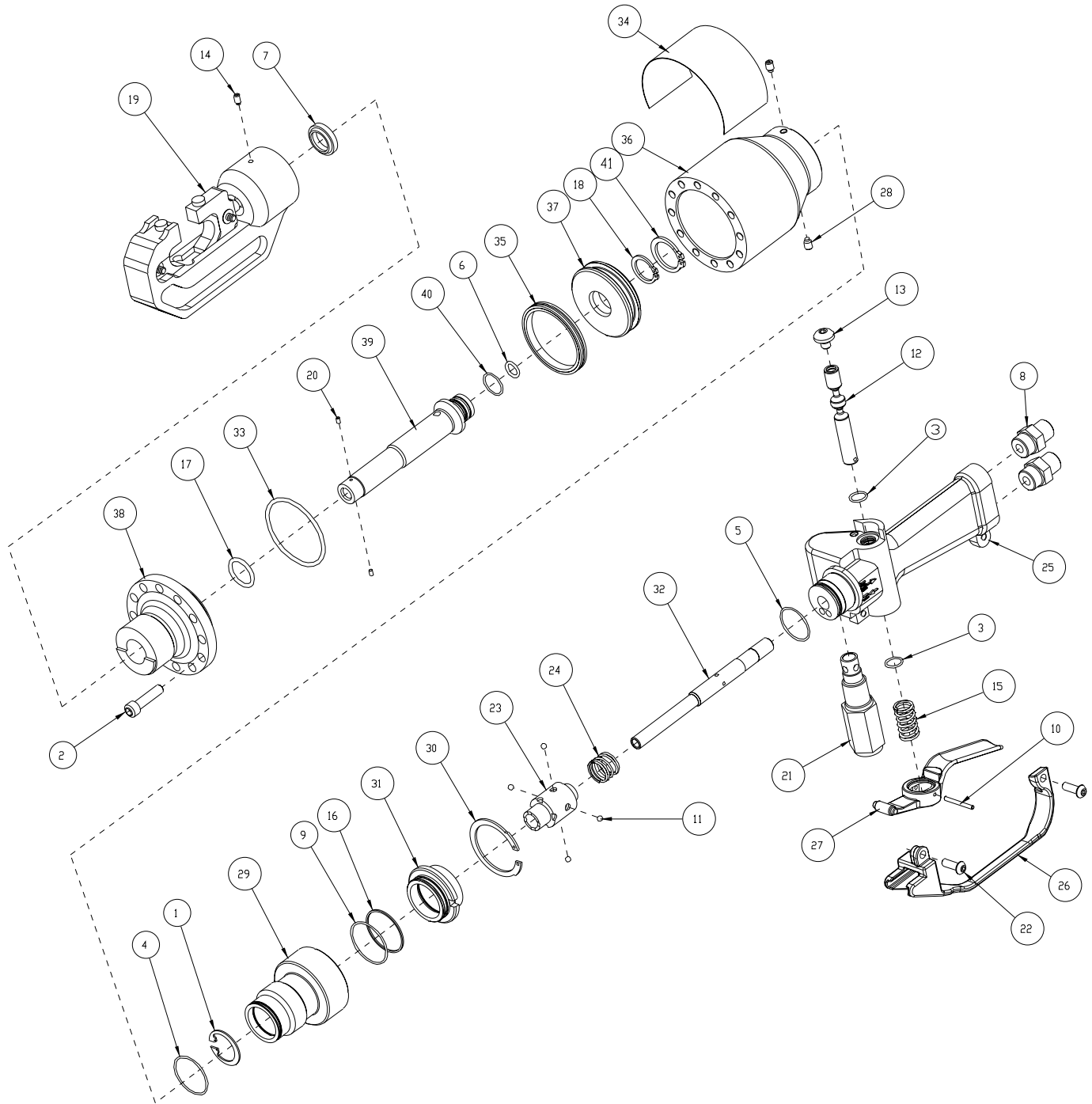

CT04 PARTS LIST

ITEM NO.	PART NO.	QTY	DESCRIPTION
1	00118	1	RETAINING RING
2	00144	12	HSCHS
3	07626	2	O-RING ■
4	09330	1	O-RING ■
5	00294	1	O-RING ■
6	00360	1	O-RING ■
7	00831	1	ROD WIPER■
8	00936	1	ADAPTER
9	01259	1	O-RING ■
10	01534	1	ROLL PIN
11	01608	4	STEEL BALL
12	01809	1	VALVE SPOOL
13	01812	1	VALVE SPOOL SCREW
14	07736	1	SETSCREW
15	16556	1	SPRING
16	18050	1	BACK-UP RING ■
17	20428	1	O-RING ■
18	20430	1	RETAINING RING EXTERNAL
19	20747	1	C FRAME – BROCK
20	21255	2	SETSCREW
21	21424	1	RELIEF VALVE
22	22147	2	CAPSCREW
23	38622	1	VALVE SLEEVE
24	39925	1	COMPRESSION SPRING
25	39939	1	VALVE HANDLE
26	51182	1	TRIGGER GUARD
27	51183	1	TRIGGER
28	52534	2	SETSCREW
29	58439	1	ADAPTER
30	58440	1	RETAINING RING
31	58441	1	SLEEVE
32	58442	1	OIL TUBE
33	58483	1	O-RING ■

ITEM NO.	PART NO.	QTY	DESCRIPTION
34	58501	1	CT04 1650 PSI COMBINED STICKER
35	58533	1	T-SEAL ■
36	58534	1	CYLINDER
37	58535	1	PISTON
38	58536	1	CYLINDER HEAD
39	58538	1	PUSH ROD
40	350850	1	O-RING ■
41	58594	1	RETAINING RING EXTERNAL
42	67259	1	CHECK VALVE ASSY
	58549	1	SEAL KIT (■ INDICATES PART IN SEAL KIT)

STANLEY®

Stanley Hydraulic Tools
3810 SE Naef Road
Milwaukie, Oregon
503-659-5660 / Fax 503-652-1780
www.stanleyhydraulics.com