

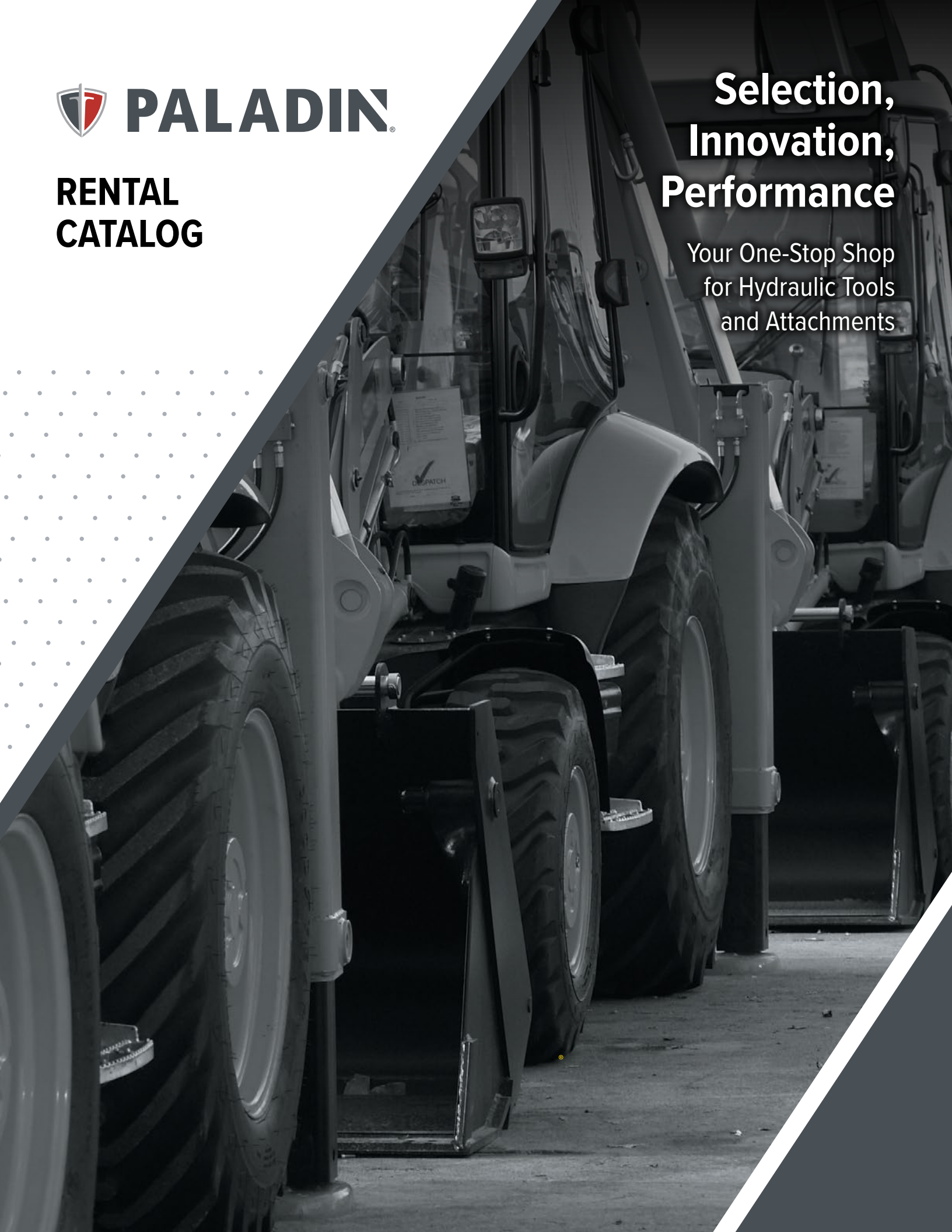

# RENTAL CATALOG

**Selection,  
Innovation,  
Performance**

Your One-Stop Shop  
for Hydraulic Tools  
and Attachments









---

# TABLE OF CONTENTS

## Skid-Steer Attachments

Auger Drives .....	4
Auger Bits/Extensions.....	5
Angle Brooms.....	6
Pick Up Sweepers.....	6
Buckets.....	7
Post Driver .....	7
Grapple Buckets.....	8
Multi-Purpose Bucket (4-in-1).....	9
Autorake®.....	9
Landscape Rakes.....	10
Concrete Claw.....	10
Concrete Chuter.....	11
Ground Shark™ Brush Cutters.....	12
Mulchers-Drum Style.....	14
Mulcher-Disk Style .....	15
Dozer Blade .....	16
Stump Grinder .....	16
Trenchers.....	17
Cold Planers.....	17
Pallet Forks.....	18
SharkBite™ Grapple.....	18
Snow Push.....	19
IceShark™ Snow Blowers .....	20

## Mini Skid-Steer Attachments

Auger Drives .....	22
Auger Bits .....	22
Buckets.....	23
Grapples.....	24
Landscape Rake .....	25
Pallet Forks.....	25
Stump Grinder .....	26
Tillers.....	26
Trenchers.....	27

## Mini Excavator Attachments

Machine Classification.....	28
Quick Hitch Buckets.....	30
Quick Hitch Couplers.....	31
Main Pin Thumbs.....	31
MX Series Brush Cutter.....	32

## Excavator Attachments

HD & Ditch Buckets .....	34
--------------------------	----

## Wheel Loader/Backhoe Attachments

Machine Classification.....	36
General Purpose Bucket.....	38
Snow Push.....	38
Construction Forks.....	39
Loader Rake.....	39

## StrikeForce™ Attachments

Breakers.....	40
Hydraulic Plate Compactors.....	41
Compaction Wheels.....	42
Drop Hammers.....	43

## AUGER DRIVE UNITS



The **McMillen® Auger Drives** by Paladin, feature a wide variety of auger diameters, lengths and style for every digging application. Comes with various mounts available for most applications.

- 5 to 60 GPM available
- Extensions available for deeper digging
- Augers available up to 48" diameter
- Planetary reduction auger drives
- 2 speed auger drives available
- Fully welded fighting for added auger strength

PART #	DESCRIPTION
124808	X1975D (15-30GPM), HEX DRIVE ASSY, SKID STEER MOUNT, W/ HOSES
24686	X1975D (15-30GPM), 2.56" ROUND DRIVE ASSY, SKID STEER MOUNT, W/ HOSES
24709	X1475D (10-25GPM), HEX DRIVE ASSY, SKID STEER MOUNT, W/ HOSES
24685	X1475D (10-25GPM), 2.56" ROUND DRIVE ASSY, SKID STEER MOUNT, W/ HOSES
124810	X2475D (20-35 GPM) HEX DRIVE ASSY, SKID STEER MOUNT, W/ HOSES
124809	X2475D (20-35GPM), 2.56" ROUND DRIVE ASSY, SKID STEER MOUNT, W/ HOSES
122715	X1475D (10-25GPM) (MINI-EX MOUNT) HEX DRIVE ASSY, QH 027 MOUNT
122712	X1975D (15-30GPM) (MINI-EX MOUNT) HEX DRIVE ASSY, QH 027 MOUNT
122713	X1975D (15-30GPM) (MINI-EX / BACKHOE MOUNT) HEX DRIVE ASSY, QH 030 MOUNT
23435	AUGER MOUNT ONLY MINI EXCAVATOR 030 COUPLER
23362	AUGER MOUNT ONLY MINI EXCAVATOR 027 COUPLER
113026	AUGER MOUNT. ONLY SKID-STEER MOUNT

# AUGER BITS / EXTENSIONS

PART #	MCMILLEN® DESCRIPTION
20036	AUGER BIT, HEAVY DUTY 6", 2" HEX, 4' HDC
20113	AUGER BIT, HEAVY DUTY 9", 2" HEX, 4' HDC
20201	AUGER BIT, HEAVY DUTY 12", 2" HEX, 4' HDC
20321	AUGER BIT, HEAVY DUTY 18", 2" HEX, 4' HDC
20401	AUGER BIT, HEAVY DUTY 24", 2" HEX, 4' HDC
20441	AUGER BIT, HEAVY DUTY 30", 2" HEX, 4' HDC
20039	AUGER BIT, HEAVY DUTY 6", 2.56" ROUND, 4'HDC
20116	AUGER BIT, HEAVY DUTY 9", 2.56" ROUND, 4' HDC
20204	AUGER BIT, HEAVY DUTY 12", 2.56" ROUND, 4' HDC
20324	AUGER BIT, HEAVY DUTY 18", 2.56" ROUND, 4' HDC
20403	AUGER BIT, HEAVY DUTY 24", 2.56" ROUND, 4' HDC
20443	AUGER BIT, HEAVY DUTY 30", 2.56" ROUND, 4' HDC
20096	AUGER BIT, LIGHT DUTY 9", 2" HEX, 4' HDF
20183	AUGER BIT, LIGHT DUTY 12", 2" HEX, 4' HDF
20306	AUGER BIT, LIGHT DUTY 18", 2" HEX, 4' HDF
20386	AUGER BIT, LIGHT DUTY 24", 2" HEX, 4' HDF
20429	AUGER BIT, LIGHT DUTY 30", 2" HEX, 4' HDF
20025	AUGER BIT, LIGHT DUTY 6", 2.56" ROUND 4' HDF
20100	AUGER BIT, LIGHT DUTY 9", 2.56" ROUND, 4' HDF
20187	AUGER BIT, LIGHT DUTY 12", 2.56" ROUND, 4' HDF
20309	AUGER BIT, LIGHT DUTY 18", 2.56" ROUND, 4' HDF
20389	AUGER BIT, LIGHT DUTY 24", 2.56" ROUND, 4' HDF
20431	AUGER BIT, LIGHT DUTY 30", 2.56" ROUND, 4' HDF
20476	AUGER BIT, LIGHT DUTY 36", 2.56" ROUND, 4' HDF
157430	ROCK AUGER BIT, 6", 2" HEX, 4'
157431	ROCK AUGER BIT, 9", 2" HEX, 4'
157433	ROCK AUGER BIT, 12", 2" HEX, 4'
157435	ROCK AUGER BIT, 18", 2" HEX, 4'
157437	ROCK AUGER BIT, 24", 2" HEX, 4'
157438	ROCK AUGER BIT, 30", 2" HEX, 4'
157439	ROCK AUGER BIT, 36", 2" HEX, 4'
21987	AUGER ADAPTER, 2" FEMALE HEX
21990	AUGER ADAPTER, 2.56" ROUND FEMALE
22851	FEX EXT ASSY, 2" HEX X 24"
22858	FEX EXT ASSY, 2" HEX X 48"
22856	FEX EXT ASSY, 2.56" X 24"
22863	FEX EXT ASSY, 2.56" X 48"
23126	VEX EXT ASSY, 2"HEX X 48"
23135	VEX EXT ASSY, 2." HEX X 72"

PART #	PENGO® DESCRIPTION
104059	TRIMAX AUGER [6-TM-48] H200
104061	TRIMAX AUGER [9-TM-48] H200
104063	TRIMAX AUGER [12-TM-48] H200
104066	TRIMAX AUGER [18-TM-48] H200
104068	TRIMAX AUGER [24-TM-48] H200
104069	TRIMAX AUGER [30-TM-48] H200
104070	TRIMAX AUGER [36-TM-48] H200
104077	TRIMAX AUGER [6-TM-48] R256 DIRT
104079	TRIMAX AUGER [9-TM-48] R256 DIRT
104081	TRIMAX AUGER [12-TM-48] R256 DIRT
104084	TRIMAX AUGER [18-TM-48] R256 DIRT
104086	TRIMAX AUGER [24-TM-48] R256 DIRT
104087	TRIMAX AUGER [30-TM-48] R256 DIRT
104088	TRIMAX AUGER [36-TM-48] R256 DIRT
PNG104152	AGGRESSOR AUGER [6-AR-49] H200
PNG104153	AGGRESSOR AUGER [9-AR-49] H200
PNG104154	AGGRESSOR AUGER [12-AR-51] H200
PNG104156	AGGRESSOR AUGER [18-AR-51] H200
PNG104157	AGGRESSOR AUGER [24-AR-51] H200
PNG104158	AGGRESSOR AUGER [30-AR-51] H200
PNG104159	AGGRESSOR AUGER [36-AR-51] H200
PNG104168	AGGRESSOR AUGER [6-AR-49] R256
PNG104169	AGGRESSOR AUGER [9-AR-49] R256
PNG104170	AGGRESSOR AUGER [12-AR-51] R256
PNG104172	AGGRESSOR AUGER [18-AR-51] R256
PNG104173	AGGRESSOR AUGER [24-AR-51] R256
PNG104174	AGGRESSOR AUGER [30-AR-51] R256
104175	AGGRESSOR AUGER [36-AR-51] R256
137950	SEVERE ROCK RIPPER AUGER ASSY [6-SRR-48] H-200
137951	SEVERE ROCK RIPPER AUGER ASSY [9-SRR-48] H-200
137952	SEVERE ROCK RIPPER AUGER ASSY [12-SRR-48] H-200
137954	SEVERE ROCK RIPPER AUGER ASSY [18-SRR-48] H-200
137956	SEVERE ROCK RIPPER AUGER ASSY [24-SRR-48] H-200
137957	SEVERE ROCK RIPPER AUGER ASSY [30-SRR-48] H-200
137958	SEVERE ROCK RIPPER AUGER ASSY [36-SRR-48] H-200
134211	ADAPTER HUB [H-200F X R256M]
557153	ADAPTER HUB [R-256F X H-200M]
134204	EXT SHFT [RE25-24] STD FIXED
134206	EXT SHFT [RE25-48] STD FIXED
557145	EXT SHFT [HE20-48] STANDARD
557146	EXT SHFT [HE20-60] STANDARD

## ANGLE BROOMS



The **Sweepster® Angle Sweeper** by Paladin, has a faceted hood design that provides maximum strength at the ends of the hood where most stress and damage occur.

- Available in 60”, 72” and 84” widths
- 32” diameter brush
- Quick change core

PART #	DESCRIPTION
22072MM-0022	72” MANUAL ANGLE BROOM SSL MOUNT
22084MM-0022	84” MANUAL ANGLE BROOM SSL MOUNT
22060MH-0022	60” HYDRAULIC ANGLE BROOM SSL MOUNT
22072MH-0022	72” HYDRAULIC ANGLE BROOM SSL MOUNT
22084MH-0022	84” HYDRAULIC ANGLE BROOM SSL MOUNT

## PICK UP SWEEPERS



**Sweepster® Skid Steer Loader Hydraulic Drive Collection Sweepers** by Paladin handles light and heavy-duty clean up in construction, municipal and industrial applications. Narrower overall attachment width for improved mobility and cleanup in confined areas.

- Hydraulic pump feature\*
- Waterless dust abatement system (WDA)

\*Optional feature depending on model.

PART #	DESCRIPTION
21560M-0022	60” PICK UP SWEEPER SSL MOUNT
21572M-0022	72” PICK UP SWEEPER SSL MOUNT
21584M-0022	84” PICK UP SWEEPER SSL MOUNT
VRS5M-0022	60” PICK UP SWEEPER W/ HIGH DUMP AND FRONT CASTER SSL MOUNT
VRS6M-0022	72” PICK UP SWEEPER W/ HIGH DUMP AND FRONT CASTER SSL MOUNT
VRS7M-0022	84” PICK UP SWEEPER W/ HIGH DUMP AND FRONT CASTER SSL MOUNT
28-10136	SPRINKLER KIT 25 GALLON TANK 205/VRS/215 12V FACTORY INSTALL
28-9139	SPRINKLER KIT 25 GALLON TANK 205/VRS/215 12V FIELD INSTALL

# BUCKETS



**Bradco® Buckets** by Paladin, are available in many styles, sizes and patterns to fit any need.

- Various sizes & edge hole patterns for common bolt-on wear edges available to assist in your jobs requirements
- High strength steel construction
- Standard tooth bars and tooth bars that fit over bolt-on wear edges available
- Tooth or smooth edge & bolt-on edges with series 23 H&L teeth available

LOW PROFILE BUCKETS WITH EDGE AND SIDE CUTTERS	
PART #	DESCRIPTION
KD15120	BUCKET, 60" LPSF,W/EDGE & SIDE CUTTERS
KD111813	BUCKET, 68" LPSF,W/EDGE & SIDE CUTTERS
KD113900	BUCKET, 72" LPSF,W/EDGE & SIDE CUTTERS
KD16270	BUCKET, 78" LPSF,W/EDGE & SIDE CUTTERS
KD16180	BUCKET, 84" LPSF,W/EDGE & SIDE CUTTERS

LOW PROFILE BUCKETS WITH TEETH AND SIDE CUTTERS	
PART #	DESCRIPTION
KD33861	BUCKET, 60" LPSF,W/TEETH & SIDE CUTTERS
KD111814	BUCKET, 68" LPSF,W/TEETH & SIDE CUTTERS
KD113901	BUCKET, 72" LPSF,W/TEETH & SIDE CUTTERS
KD16265	BUCKET, 78" LPSF,W/TEETH & SIDE CUTTERS
KD16190	BUCKET, 84" LPSF,W/TEETH & SIDE CUTTERS

# POST DRIVER



**The Bradco® Post Driver** is designed to be operated with an SSL or CTL for driving posts up to 10 feet in length and up to 8 inches in diameter. Works with round or square posts; also compatible for recatangles such as guard rails. Quick change collars allow for changing from a smaller post collar to a larger one in a matter of minutes. Up to 30 hit a minute.

PART #	DESCRIPTION
111487	PD4800 POST DRIVER ONLY **MUST CHOOSE OPTIONS
112491	8.0in SQUARE COLLAR W/STRIKER PLATE ASSEMBLY
112920	108in HOSE KIT W/ 1/2in QC

# GRAPPLE BUCKETS

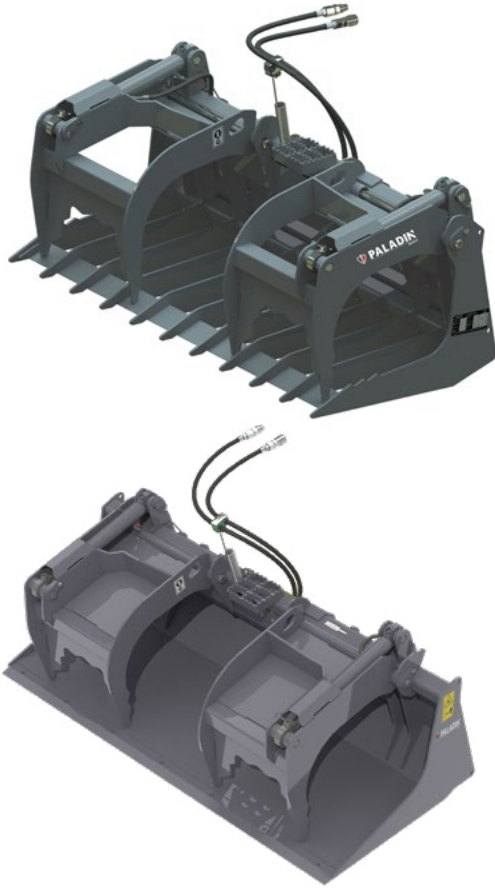

The **FFC® Brush and Scrap Grapples** by Paladin, have been designed to prevent the roll back interference that occurred on some newer models of skid steer loaders and also offers hose length options.

- Patented design withstands the demands of work in scrap handling, recycling, and other tough applications
- Full feature includes hardened pins, cushioned cylinder kit, and cylinder/hose guard for model 120

PART #	DESCRIPTION
123668	60" STANDARD DUTY SCRAP GRAPPLE W/ BOE (12860-0022) SSL MOUNT INCLUDES 88" HOSE KIT, 90 DEG CPL, & HOSE SAVER (103179)
123669	66" STANDARD DUTY SCRAP GRAPPLE W/ BOE (12866-0022) SSL MOUNT INCLUDES 88" HOSE KIT, 90 DEG CPL, & HOSE SAVER (103179)
123670	72" STANDARD DUTY SCRAP GRAPPLE W/ BOE (12872-0022) SSL MOUNT INCLUDES 88" HOSE KIT, 90 DEG CPL, & HOSE SAVER (103179)
123671	76" HEAVY DUTY SCRAP GRAPPLE W/ BOE (11876-0022) SSL MOUNT INCLUDES 88" HOSE KIT, 90 DEG CPL, & HOSE SAVER (103179)
123672	82" HEAVY DUTY SCRAP GRAPPLE W/ BOE (11882-0022) SSL MOUNT INCLUDES 88" HOSE KIT, 90 DEG CPL, & HOSE SAVER (103179)
123661	60" STANDARD DUTY BRUSH GRAPPLE (12260-0022) SSL MOUNT INCLUDES 88" HOSE KIT, 90 DEG CPL, & HOSE SAVER (103179)
123662	66" STANDARD DUTY BRUSH GRAPPLE (12266-0022) SSL MOUNT INCLUDES 88" HOSE KIT, 90 DEG CPL, & HOSE SAVER (103179)
123663	72" STANDARD DUTY BRUSH GRAPPLE (12272-0022) SSL MOUNT INCLUDES 88" HOSE KIT, 90 DEG CPL, & HOSE SAVER (103179)
123664	72" HEAVY DUTY BRUSH GRAPPLE (11372-0022) SSL MOUNT INCLUDES 88" HOSE KIT, 90 DEG CPL, & HOSE SAVER (103179)
123665	78" HEAVY DUTY BRUSH GRAPPLE (11378-0022) SSL MOUNT INCLUDES 88" HOSE KIT, 90 DEG CPL, & HOSE SAVER (103179)
123666	84" HEAVY DUTY BRUSH GRAPPLE (11384-0022) SSL MOUNT INCLUDES 88" HOSE KIT, 90 DEG CPL, & HOSE SAVER (103179)
<b>ROOT RAKE, SKID STEER LOADER</b>	
123685	72" ROOT RAKE UNIV SSL MOUNT W/ 84" HOSE KIT (121152)
123682	78" ROOT RAKE UNIV SSL MOUNT W/ 76" HOSE KIT (121152)
123683	84" ROOT RAKE UNIV SSL MOUNT W/ 84" HOSE KIT (121152)



## MULTI-PURPOSE BUCKET (4-IN-1)



The **Bradco® 4-in-1 Multipurpose Bucket** functions as a loader bucket, clam, grapple, dozer, box scraper and bottom dump bucket.

- Made of lightweight material with heavy duty hinges and pins
- Evenly distributes the load and provides the ability to handle more load capacity

PART #	DESCRIPTION
108022	72" 4IN1 SKID STEER BUCKET (HEAVY DUTY), CHOOSE BOE & HOSE KIT
108024	78" 4IN1 SKID STEER BUCKET (HEAVY DUTY), CHOOSE BOE & HOSE KIT
108026	84" 4IN1 SKID STEER BUCKET (HEAVY DUTY), CHOOSE BOE & HOSE KIT
108023	72" 4IN1 SKID STEER BUCKET WITH TEETH (HEAVY DUTY), CHOOSE HOSE KIT
108025	78" 4IN1 SKID STEER BUCKET WITH TEETH (HEAVY DUTY), CHOOSE HOSE KIT
108027	84" 4IN1 SKID STEER BUCKET WITH TEETH (HEAVY DUTY), CHOOSE HOSE KIT
103577	HOSE KIT FOR 4IN1 BUCKET
15028	72" BOLT ON EDGE FOR 4IN1 BUCKET
16204	78" BOLT ON EDGE FOR 4IN1 BUCKET
16183	84" BOLT ON EDGE FOR 4IN1 BUCKET

## AUTORAKE®



**FFC® AutoRake®** by Paladin, an easy to use site clean-up and soil preparation attachment. This unit can be mounted on three-point configuration (tractor) and is excellent for picking up windrows in support of power box rake operations.

PART #	DESCRIPTION
LAF6864-0022	66" AUTORAKE UNIV SSL MOUNT
LAF6874-0022	76" AUTORAKE UNIV SSL MOUNT

## LANDSCAPE RAKES



**Harley® and FFC® Power Rakes**, by Paladin, are the highest quality, most durable and versatile power rakes available. They are widely regarded as the “gold standard” for power rakes by landscaping professionals. These rakes have been engineered to create the most optimal seedbed conditions leading to lush grass and beautiful landscaping.

PART #	DESCRIPTION
<b>LANDSCAPE RAKES, SKID STEER LOADER</b>	
M6M-0022	6' MANUAL ANGLE HARLEY RAKE, SSL
M6H-0022	6' HYDRAULIC ANGLE HARLEY RAKE, SSL
MX7H-0022	7' HYDRAULIC ANGLE HARLEY RAKE, SSL
MX8H-0022	8' HYDRAULIC ANGLE HARLEY RAKE, SSL
LAF5672-0022	72" MANUAL ANGLE DIRECT DRIVE POWER RAKE, SSL
<b>LANDSCAPE RAKES, TRACTOR 3-POINT</b>	
T6M-0052	6' MANUAL ANGLE TRACTOR 3 POINT HARLEY RAKE
T6H-0052	6' HYDRAULIC ANGLE TRACTOR 3 POINT HARLEY RAKE

## CONCRETE CLAW



The **FFC® Concrete Claw**, is ruggedly designed for removing concrete sidewalks and driveways or on any construction site and can be used for shrub and stump removal.

PART #	DESCRIPTION
10024-0022	CONCRETE CLAW, SSL MOUNT

# CONCRETE CHUTER



The FFC® Concrete Chuter is designed for accurate placement of concrete in tight spaces on job sites where cement trucks can't go. Never wheelbarrow or pump concrete again!

PART #	DESCRIPTION
11050-0022	½ YD CONCRETE CHUTER W/HOSES
11075-0022	¾ YD CONCRETE CHUTER W/HOSES



# GROUND SHARK BRUSH CUTTERS

## STANDARD DUTY



### SD FEATURES

- Drive train is designed for maximum performance, efficiency and reliability
- Optional under-mount steel wheels
- Three bi-directional blades
- Optional pressure gauge
- Dual pressure reliefs on the hydraulic motor protect against pressure spikes that could damage the drive system
- Standard flow equipped with .5" couplers (you must specify when ordering high-flow units)

## HEAVY & EXTREME DUTY



### HD & XD FEATURES

- Retracting debris shield exposes blades, for aggressive full-depth cuts
- .25" steel "clean deck" design with high-quality powder coat helps keep clear of debris and is easier to clean and maintain
- Alternating bevel blade design provides a deep penetrating, self-clearing cut
- Blades made of .75" thick high-grade steel with reversible design for added blade life

### HEAVY DUTY BLADES



### EXTREME DUTY BLADES

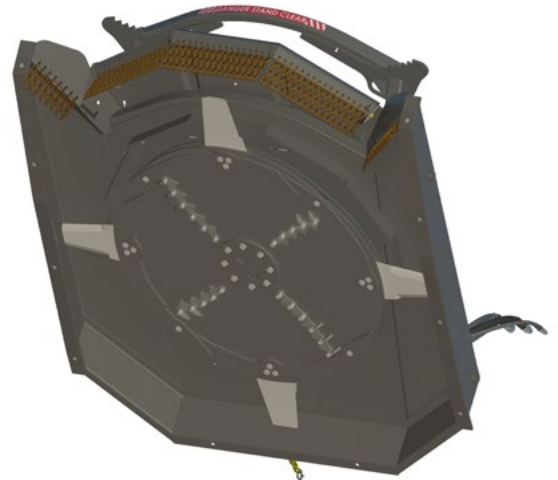

# GROUND SHARK BRUSH CUTTERS

PART #	DESCRIPTION
30360A-0022	60" STANDARD DUTY (SD) BRUSH CUTTER, 15-25 GPM, 1/2" QDs
30372A-0022	72" STANDARD DUTY (SD) BRUSH CUTTER, 15-25 GPM, 1/2" QDs
30378A-0022	78" STANDARD DUTY (SD) BRUSH CUTTER, 15-25 GPM, 1/2" QDs
31766-0022	66" HEAVY DUTY (HD) BRUSH CUTTER, 20-34 GPM, 1/2" QDs
31772-0022	72" HEAVY DUTY (HD) BRUSH CUTTER, 20-34 GPM, 1/2" QDs
31766-9925	66" HEAVY DUTY (HD) BRUSH CUTTER, 20-34 GPM, 3/4" QDs
31772-9925	72" HEAVY DUTY (HD) BRUSH CUTTER, 20-34 GPM, 3/4" QDs
31766-9903	66" HEAVY DUTY (HD) BRUSH CUTTER, 20-34 GPM, 5/8" QDs
31772-9903	72" HEAVY DUTY (HD) BRUSH CUTTER, 20-34 GPM, 5/8" QDs
30272-0022	72" EXTREME DUTY (XD) BRUSH CUTTER, 30-45 GPM, 1/2" QDs
30278-0022	78" EXTREME DUTY (XD) BRUSH CUTTER, 30-45 GPM, 1/2" QDs
30272-9925	72" EXTREME DUTY (XD) BRUSH CUTTER, 30-45 GPM, 3/4" QDs
30278-9925	78" EXTREME DUTY (XD) BRUSH CUTTER, 30-45 GPM, 3/4" QDs
30272-9903	72" EXTREME DUTY (XD) BRUSH CUTTER, 30-45 GPM, 5/8" QDs
30278-9903	78" EXTREME DUTY (XD) BRUSH CUTTER, 30-45 GPM, 5/8" QDs
<b>CUTTING BLADES</b>	
118330	STANDARD DUTY 60"
118331	STANDARD DUTY 72"
118332	STANDARD DUTY 78"
123735	HEAVY DUTY 66"
123736	HEAVY DUTY 72"
117194	EXTREME DUTY 72", 78"
<b>CARBIDE STUMP GRINDING TEETH</b>	
123781	HEAVY DUTY 66"
123733	HEAVY DUTY 72"
117193	EXTREME DUTY 72"
123734	EXTREME DUTY 78"
<b>SKID SHOE KIT</b>	
117810	STANDARD DUTY 60", 72", 78"
123544	HEAVY DUTY 66"
117192	HEAVY DUTY 72"
117192	EXTREME DUTY 72"
123639	EXTREME DUTY 78"
<b>DUAL WHEEL KIT</b>	
118333	STANDARD DUTY 60", 72", 78"
<b>SKID SHOE KIT</b>	
117824	STANDARD DUTY 60", 72", 78"
123642	HEAVY DUTY 66", 72"
INCLUDED	EXTREME DUTY 72", 78"

# MULCHERS - DRUM STYLE



- Shreds up to 8" diameter hardwood trees
- Patented tooth design and easily interchangeable tooth design options
- Replaceable abrasion resistant AR400 wear plate on skid shoes
- Deflector door standard to control particle size and discharge direction
- Reversible teeth double the useful life vs. single-edge styles

PART #	DESCRIPTION
124171*	60" DRUM MULCHER, CLAW TEETH, 30-45 GPM
125346*	60" DRUM MULCHER, REVERSIBLE CARBIDE HAMMERS, 30-45 GPM
124652*	72" DRUM MULCHER, CLAW TEETH, 30-45 GPM
126008*	72" DRUM MULCHER, REVERSIBLE CARBIDE HAMMERS, 30-45 GPM
* Includes Standard Control Kit and 3/8" Female Case Drain; Requires Hoses	
HOSE KITS (REQUIRED)	
233133	80" HOSES WITH 1/2" QDs
233134	80" HOSES WITH 5/8" QDs
110915	80" HOSES WITH 3/4" QDs
84923*	3/8" MALE CASE DRAIN COUPLER*
*Required for Case/CNH Machines	
REPLACEMENT TEETH	
116092	60" DRUM STYLE, REVERSIBLE CLAW TEETH KIT
112578	72" DRUM STYLE, REVERSIBLE CLAW TEETH KIT
116091	60" DRUM STYLE, REVERSIBLE CARBIDE HAMMER KIT
111794	72" DRUM STYLE, REVERSIBLE CARBIDE HAMMER KIT
STANDARD CONTROL KIT	
LAF9360-0000	KUBOTA, CASE, TAKEUCHI, NEW HOLLAND, VOLVO, JCB
OPTIONAL CONTROL KIT	
07-9548	BOBCAT 2012+
119741	CAT XHP D
119740	CAT XPS D
07-7626	JOHN DEERE EH
LAF9361-0000	JOHN DEERE F
07-10170	KOMATSU
OIL COOLERS	
115851	MM60 SERIES II FACTORY INSTALLED
115852	MM60 SERIES II DEALER INSTALLED
115853	MM72 SERIES II FACTORY INSTALLED
115854	MM72 SERIES II DEALER INSTALLED



## MULCHERS - DISK STYLE



- Designed to reduce jamming
- Ultra-efficient drive system with fast start
- MulchPower™ Gauge for maximum energy
- Bearing housing never needs to be greased
- Debris shovel keeps teeth out of the dirt and guides material for processing
- High-quality QUADCO teeth are interchangeable, allowing for simple service and rotation
- Fells trees up to 14"
- Processes up to 8"
- Stump grinds to grade

PART #	DESCRIPTION
125260-0022	60" FORESTRY DISC MULCHER, 1/2" QD, 3/8" CASE DRAIN, 30-45 GPM
125260-9903	60" FORESTRY DISC MULCHER, 5/8" QD, 3/8" CASE DRAIN, 30-45 GPM
125260-9925	60" FORESTRY DISC MULCHER, 3/4" QD, 3/8" CASE DRAIN, 30-45 GPM
CONSUMABLES AND REPLACEMENTS	
125288	PARTIAL TOOTH REPLACEMENT KIT (20 TEETH AND HARDWARE)
125984	RIGHT-SIDE SKID SHOE REPLACEMENT KIT
125985	LEFT-SIDE SKID SHOE REPLACEMENT KIT
125986	DEBRIS SHOVEL REPLACEMENT KIT
125959	SWINGING DEBRIS DOOR REPLACEMENT KIT

## DOZER BLADE



**Bradco® Dozer Blade** by Paladin, with tilt attach, tilts the dozer blade for more precise grading, leveling and trenching. This means that you get to the next job quicker!

- Hydro-electric controlled angle and tilt, using only one loader valve
- Angle 30° right or left of center
- Tilt 10° off horizontal both directions
- Tilt indicator visible from operator's seat

PART #	DESCRIPTION
88861	7' DOZER BLADE, SSLMOUNT, ADD CONTROL BOX 15756 or SPECIFIC HARNESS
89681	8' DOZER BLADE, SSL MOUNT, ADD CONTROL BOX 15756 or SPECIFIC HARNESS
15756	UNIVERSAL CONTROL BOX, 12V

## STUMP GRINDER



The **Bradco® Stump Grinder** by Paladin, is available in standard and high flow. The standard flow model has a 26" diameter cutting wheel allowing up to 10" of below ground cutting. and the high flow model has a 30" wheel allowing up to 12" of below ground cutting.

- Tooth pattern permits cutting from side-to-side and vertical directions
- Wheel and tooth options available
- Heavy-duty gearbox drives with torque arm motor support for longer motor and drive system life
- Easy access to all drive components allows for quick maintenance

PART #	DESCRIPTION
100319	STUMP GRINDER SG26, STANDARD FLOW ** MUST ORDER WHEEL, HOSES, & CONTROLS
101234	WHEEL ASSEMBLY, SQUARE TEETH
100984	HOSE KIT, 88", 1/2" QD
104367	UNIVERSAL CONTROL BOX, STUMP GRINDER

## TRENCHERS



**Bradco® Trenchers** by Paladin, can mount to skid-steer loaders, compact skid-steer loaders and 3-point PTO HP hydrostatic tractors. Several boom lengths are available to match your job's specifications.

- Standard flow and high flow options are available
- Choose from various chain and teeth assemblies

PART #	DESCRIPTION
117765	TRENCHER ASSY, 48" BOOM X 6" CHAIN (CUP TOOTH EVERY STATION), SSL MOUNT W/ 97" HOSE KIT
117766	TRENCHER ASSY, 48" BOOM X 6" CHAIN (70/30 TOOTH EVERY STATION), SSL MOUNT W/ 97" HOSE KIT

## COLD PLANERS



The **Bradco® Cold Planers** by Paladin, is an effective tool for small milling jobs, as well as asphalt and concrete pothole and frost heave repair, curb cutting, pavement texturing and removal of traffic lane stripes and roadway around manholes.

The **FFC® Asphalt Mills** by Paladin, can be used to make full depth utility cuts, mill frost heaves around manholes, restore proper drainage to pavement, add texture to pavement for skid resistance, and more.

PART #	DESCRIPTION
COLD PLANERS STANDARD FLOW SKID STEER LOADER	
101196	12" COLD PLANER STANDARD FLOW HYD SIDE-SHIFT
ASPHALT MILLS SKID STEER LOADER	
LAF5413-0022	16" COLD PLANER STD FLOW 3-LINE SSL MOUNT
LAF5424-0022	24" COLD PLANER HIGH FLOW 3-LINE SSL MOUNT W/ CONTROL BOX



## PALLET FORKS



**Bradco® Pallet Forks** feature heavy-duty frames designed to handle up to 6,200 lb. fork capacities without taxing the loader's power or lift capacity.

- Lever style locks provide additional leverage when operating the tine latching mechanism
- Excellent see through visibility allows the operator to see the ends
- Custom branded fork carriage available

PART #	DESCRIPTION
30945-0022	PALLET FORK FRAME ONLY SSL MOUNT
67604	48" 4000# CAPACITY FORKS (PAIR)

## SHARKBITE™ GRAPPLE



SharkBite™ installs onto any ISO-standard class II ITA fork rail, transforming a regular set of pallet forks into an ultra-versatile grapple. Optional bolt-on Shark Teeth extend the durability and gripping performance of SharkBite, and the high-strength steel construction and powder-coat finish means SharkBite is built to last.

PART #	DESCRIPTION
233180	SHARKBITE ASSEMBLY - FORK AND FRAME SOLD SEPERATELY
233215	OPTIONAL REVERSIBLE AR400 HARDENED TEETH (QTY 6 - FIELD INSTALL)

# SNOW PUSH



The **FFC Snow Push**, by Paladin is engineered of heavy-duty, fully welded steel with 3/8" thick end plates to capture and remove even the heaviest snow without leaving windrows or spillover. For SSL, Compact Utility Loaders, Small Wheel Loaders and Backhoe Loaders.

PART #	DESCRIPTION
23296-0022	8' LOW PROFILE SNOW PUSH SSL MOUNT
23220-0022	10" LOW PROFILE SNOW PUSH SSL MOUNT
23320-0022	10" 3' X 3' SNOW PUSH SSL MOUNT

# ICESHARK™ 250 SERIES SNOW BLOWERS



## FEATURES

- The new patented backdrag options allows operators to remove snow as close as 6" from a garage or wall to minimize the amount of shoveling required
- The built in yellow indicators guide users as they get close to a structure and give the operator guidance before engaging the backdrag functionality
- The new 3D floating hitch offers side to side, up and down, and front to back motion to allow the snow blower to have the smoothest operating experience when working on uneven surfaces
- The 3D floating hitch also allows for an uninterrupted scrape offering a cleaner surface which means less salt is required
- The dual articulating shoot offering unprecedented user control on where to place the snow with the 270 degrees of motion and ability to blow snow from as close as 3 feet or up to 45 feet
- The skid skis offer toolless adjustment which enable users to quickly and easily transition from gravel to pavement

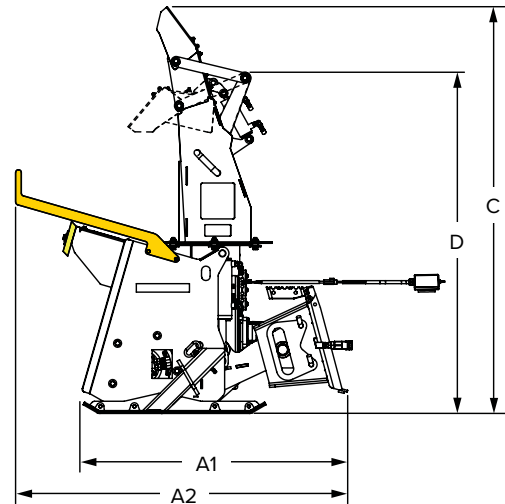
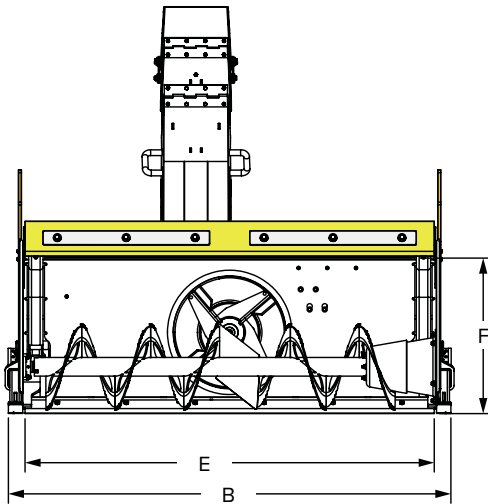

ICESHARK SNOW BLOWERS SPECIFICATIONS	COMPACT & STANDARD FLOW				HIGH FLOW	
	48"	60"	72"	84"	72"	84"
A1. OVERALL LENGTH WITHOUT BACKDRAG	46"	46"	46"	46"	49.3"	49.3"
A2. OVERALL LENGTH WITH BACKDRAG*	-	57.8"	57.8"	57.8"	61.3"	61.3"
B. OVERALL WIDTH	53"	65"	77"	89"	77"	89"
C. MAXIMUM OVERALL HEIGHT	71"	71"	71"	71"	78"	78"
D. MINIMUM OVERALL HEIGHT	60"	60"	60"	60"	65.75"	65.75"
E. CUTTING WIDTH	48"	60"	72"	84"	72"	84"
F. CUTTING HEIGHT	27.5"	27.5"	27.5"	27.5"	34"	34"
HYDRAULIC PRESSURE	3500 PSI				4200 PSI	

\*BACKDRAG NOT AVAILABLE IN 48" MODELS



# ICESHARK™ 250 SERIES SNOW BLOWERS

PART #	DESCRIPTION
25048B-0022	48" COMPACT FLOW SNOW BLOWER, 8-15 GPM, NO BACKDRAG
25060D-0022	60" STANDARD FLOW SNOW BLOWER, 15-27 GPM, NO BACKDRAG
25060DBD-0022	60" STANDARD FLOW SNOW BLOWER, 15-27 GPM, BACKDRAG INCLUDED
25072D-0022	72" STANDARD FLOW SNOW BLOWER, 15-27 GPM, NO BACKDRAG
25072DBD-0022	72" STANDARD FLOW SNOW BLOWER, 15-27 GPM, BACKDRAG INCLUDED
25084D-0022	84" STANDARD FLOW SNOW BLOWER, 15-27 GPM, NO BACKDRAG
25084DBD-0022	84" STANDARD FLOW SNOW BLOWER, 15-27 GPM, BACKDRAG INCLUDED
25072F-0022	72" HIGH FLOW SNOW BLOWER, 27-35 GPM, NO BACKDRAG
25072FBD-0022	72" HIGH FLOW SNOW BLOWER, 27-35 GPM, BACKDRAG INCLUDED
25084F-0022	84" HIGH FLOW SNOW BLOWER, 27-35 GPM, NO BACKDRAG
25084FBD-0022	84" HIGH FLOW SNOW BLOWER, 27-35 GPM, BACKDRAG INCLUDED
25072H-0022	72" EXTRA HIGH FLOW SNOW BLOWER, 35-45 GPM, NO BACKDRAG
25072HBD-0022	72" EXTRA HIGH FLOW SNOW BLOWER, 35-45 GPM, BACKDRAG INCLUDED
25084H-0022	84" EXTRA HIGH FLOW SNOW BLOWER, 35-45 GPM, NO BACKDRAG
25084HBD-0022	84" EXTRA HIGH FLOW SNOW BLOWER, 35-45 GPM, BACKDRAG INCLUDED

## REPLACEMENT AND OPTIONAL CONTROLS

LAF9394-0000	REPLACEMENT INDEPENDENT CONTROL BOX, POWER FROM MACHINE BATTERY (INCLUDED IN -0022 MODELS)
07-9548	WIRE HARNESS FOR INTEGRATED MACHINE CONTROLS, 7-PIN, FITS ALL SERIES 2012+, FOR BOBCAT
07-10021	WIRE HARNESS FOR INTEGRATED MACHINE CONTROLS, 8-PIN, FITS ALL SERIES, FOR CAT PRE-B
07-10122	WIRE HARNESS FOR INTEGRATED MACHINE CONTROLS, 8-PIN, FITS A-E SERIES, FOR CAT B AND C
07-10170	WIRE HARNESS FOR INTEGRATED MACHINE CONTROLS, 8-PIN, FITS F2-H SERIES, FOR CAT B AND C
07-8344	WIRE HARNESS FOR INTEGRATED MACHINE CONTROLS, 14-PIN, FITS A-E SERIES, FOR CAT D
LAF9360-0000	WIRE HARNESS FOR INTEGRATED MACHINE CONTROLS, 14-PIN, FITS ALL SERIES, FOR BOBCAT / KUBOTA (W MULTI-FUNCTION IN CAB CONTROLS) / CNH / JCB
LAF9393	WIRE HARNESS FOR INTEGRATED MACHINE CONTROLS, 8-PIN, FITS ALL SERIES, FOR CNH
07-7338	WIRE HARNESS FOR INTEGRATED MACHINE CONTROLS, 3-PIN, FITS ALL SERIES, FOR JOHN DEERE
LAF9361	WIRE HARNESS FOR INTEGRATED MACHINE CONTROLS, 14-PIN, FITS ALL SERIES, FOR JOHN DEERE-8 BUTTON
07-7626	WIRE HARNESS FOR INTEGRATED MACHINE CONTROLS, 14-PIN, FITS ALL SERIES, FOR JOHN DEERE EH CONTROL
07-10194	WIRE HARNESS FOR INTEGRATED MACHINE CONTROLS, 14-PIN, FITS ALL SERIES, FOR KOMATSU
07-10057	WIRE HARNESS FOR INTEGRATED MACHINE CONTROLS, 8-PIN, FITS ALL SERIES, FOR KOMATSU

## OPTIONAL BACKDRAG KITS

28-11225-60	60" STANDARD FLOW
28-11225-72	72" STANDARD FLOW
28-11225-84	84" STANDARD FLOW
28-11219-72	72" HIGH FLOW, 72" EXTRA HIGH FLOW
28-11219-84	84" HIGH FLOW, 84" EXTRA HIGH FLOW

## DUAL WHEEL KIT

28-11300-48	48" STEEL EDGE KIT, INCLUDES HARDWARE
28-1130-60	60" STEEL EDGE KIT, INCLUDES HARDWARE
28-11300-72	72" STEEL EDGE KIT, INCLUDES HARDWARE
28-11300-84	84" STEEL EDGE KIT, INCLUDES HARDWARE
28-11301-48	48" POLYURETHANE EDGE KIT, INCLUDES HARDWARE
28-11301-60	60" POLYURETHANE EDGE KIT, INCLUDES HARDWARE
28-11301-72	72" POLYURETHANE EDGE KIT, INCLUDES HARDWARE
28-11301-84	84" POLYURETHANE EDGE KIT, INCLUDES HARDWARE
28-11312	STEEL WEAR SHOE KIT, INCLUDES HARDWARE
28-11313	SOFT WEAR SHOE KIT, INCLUDES HARDWARE

## MINI AUGER DRIVES



- X1500 provides high torque
- 2.5625" round shaft (X900 & X1500 models)
- 2.0" hex shaft (X1500 model only)
- Over 30 auger bits available to fit your job specifications

PART #	DESCRIPTION
24861	X1500 AUGER DRIVE, 8.0 CU 2" HEX, MINI SSL UNIVERSAL MOUNT
24453	X1500 AUGER DRIVE, 8.0 CU 2.56" ROUND, MINI SSL UNIVERSAL MOUNT

## AUGER BITS

PART #	DESCRIPTION
20035	AUGER BIT, HEAVY DUTY 6" 2.56" ROUND x 3'
20112	AUGER BIT, HEAVY DUTY 9" 2.56" ROUND x 3'
20200	AUGER BIT, HEAVY DUTY 12" 2.56" ROUND x 3'
20320	AUGER BIT, HEAVY DUTY 18" 2.56" ROUND x 3'
20399	AUGER BIT, HEAVY DUTY 24" 2.56" ROUND x 3'
20033	AUGER BIT, HEAVY DUTY 6" 2" HEX x 3'
20109	AUGER BIT, HEAVY DUTY 9" 2" HEX x 3'
20198	AUGER BIT, HEAVY DUTY 12" 2" HEX x 3'
20318	AUGER BIT, HEAVY DUTY 18" 2" HEX x 3'
20397	AUGER BIT, HEAVY DUTY 24" 2" HEX x 3'

## MINI BUCKETS

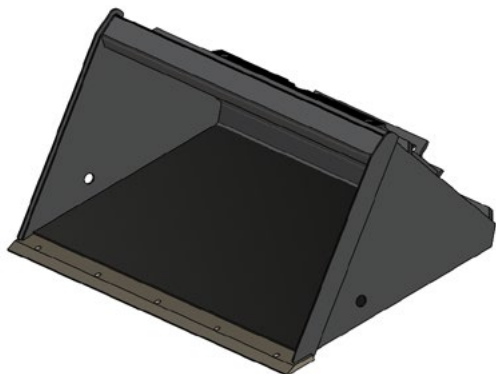

**Bradco® Mini Buckets** are available with Toro/Dingo, ASV and Bobcat MT Series mounts. Bucket widths 42" (4 and 6 cu. ft. capacity) and 48" (4 and 6 cu. ft. capacity). Buckets available with weld-on teeth or tooth bars.

PART #	DESCRIPTION
<b>SMOOTH BUCKET, MINI SKID STEER UNIVERSAL MOUNT</b>	
117506	36" (4 FT <sup>3</sup> ) SMOOTH BUCKET, MINI SSL
2000872	42" (4 FT <sup>3</sup> ) SMOOTH BUCKET, MINI SSL
107783	44" (7 FT <sup>3</sup> ) SMOOTH LIGHT MATERIAL BUCKET, MINI SSL
2000877	48" (6 FT <sup>3</sup> ) SMOOTH BUCKET, MINI SSL
<b>TOOTH BUCKET, MINI SKID STEER UNIVERSAL MOUNT</b>	
119300	36" (4 FT <sup>3</sup> ) TOOTH BUCKET, MINI SSL
19405	42" (4 FT <sup>3</sup> ) TOOTH BUCKET, MINI SSL
104579	48" (6 FT <sup>3</sup> ) TOOTH BUCKET, MINI SSL

# MINI GRAPPLES

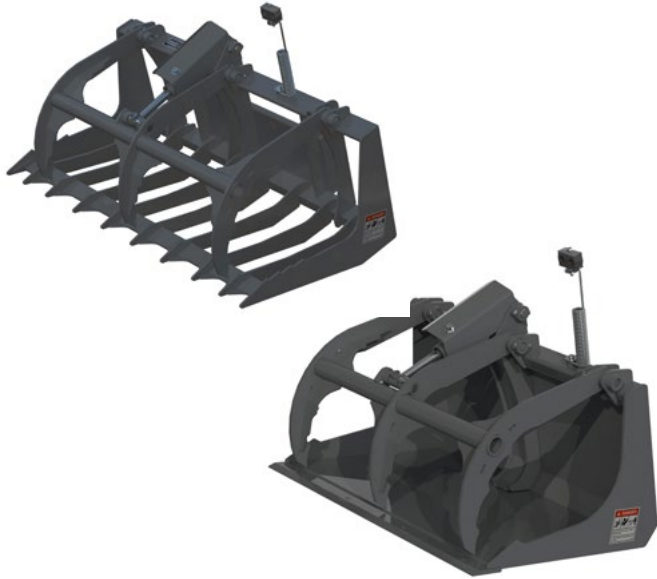

- The brush grapple is ideally suited for moving brush, limbs and branches. The open tine design allows the vegetative material to be moved while allowing soil to drop through and remain behind
- The solid floor scrap grapple make it the ideal mini skid steer tool for scrap and yard waste removal and construction sites, especially in tight areas

PART #	DESCRIPTION
<b>BRUSH GRAPPLE, MINI SKID STEER UNIVERSAL MOUNT</b>	
107036	42" BRUSH GRAPPLE, MINI SSL
107037	48" BRUSH GRAPPLE, MINI SSL
<b>SCRAP GRAPPLE, MINI SKID STEER UNIVERSAL MOUNT</b>	
107148	42" SCRAP GRAPPLE, MINI UNIVERSAL SSL MOUNT
123978	48" SCRAP GRAPPLE, MINI UNIVERSAL SSL MOUNT
<b>HARDSCAPE GRAPPLE MINI SKID STEER</b>	
23548-0961	HARDSCAPE GRAPPLE - MINI SSL



## MINI LANDSCAPE RAKE



- Direct drive motor is embedded within frame and drum providing optimal protection from dirt and debris.
- Adjustable Rhino-Hide barrier
- Specially shaped and placed carbide teeth ensure the best possible seedbed
- Easily removable end plates

PART #	DESCRIPTION
22748M-0961	48" HARLEY RAKE MANUAL ANGLE MINI SSL
22748H-0961	48" HARLEY RAKE HYDRAULIC ANGLE MINI SSL

## MINI PALLET FORKS



- Adjustable tine widths
- Heavy-duty, easy on and off

PART #	DESCRIPTION
108366	PALLET FORKS, MINI SKID STEER UNIVERSAL MOUNT
106220	42" PALLET FORKS FOR 108366
106222	48" PALLET FORKS FOR 108366

## MINI STUMP GRINDER



- Bearing mounted cutting wheel provides smooth, trouble-free operation
- Adjustable wheel cutting angle allows optimal cutting for any type of stump

PART #	DESCRIPTION
101866	STUMP GRINDER, MINI, 10 to 14 GPM (MUST SELECT MOUNT, WHEEL, & HOSES)
101868	UNIVERSAL MINI MOUNT (NON BOBCAT) FOR STUMP GRINDER
104374	BOBCAT MOUNT FOR STUMP GRINDER
101876	WHEEL ASSEMBLY W/BOLT ON TEETH
101874	HOSE KIT, FLAT FACE

## MINI TILLERS



- Replaceable and reversible tines
- Adjustable depth guide
- 8 to 15 GPM recommended
- 1,500 to 3,000 operating pressure (PSI)

PART #	DESCRIPTION
2008000	40" TILLER, MINI SSL























## MINI TRENCHERS



- 24", 30", 36" & 48" digging depths
- 6" to 12" wide chains available
- Operating pressure (psi) 2,000 to 3,000
- GPM requirements 6-10 or 10-16
- Standard tooth, shark tooth, or combo available



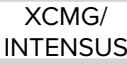















PART #	DESCRIPTION
118618	TRENCHER, 615,10-16 GPM 30" BOOM, 6.0" 70/30, MINI SSL
118621	TRENCHER, 615,10-16 GPM 36" BOOM, 4.5" 70/30, MINI SSL
113344	TRENCHER, 615,10-16 GPM 36" BOOM, 6.0" 70/30, MINI SSL

# MINI / BACKHOE / EXCAVATORS MACHINE CLASSIFICATION

METRIC TON CLASS	01mT	02mT	03mT	05mT	08mT	12mT	15mT		
BACKHOE CLASS			BH <13'		BH 13'-17'		BH>17'		
CLASS	100 MINI	200 MINI	300 MINI	400 MINI	10	20	710	25	35
CWS CLASS		BE15	BE30	BE40	BE60	BE80		HE120	HE150
RANGE						R3	R4	R4	R5
 <b>Bobcat</b>	E10	E20	E26**, E32, E32i, E35, E35i	E42, E45, E50 E55, E63		E85		E145	
 <b>CASE</b>		CX17B, CX17C	CX26C**, CX30C, CX31B, CX33C, CX36B, CX37C	CX55B, CX57C, CX60C	580N, 580SN, 580SNWT, 590N, 590SN	CX75C SR, CX80C		CX140E, CX130D, CX135C CS, CX145C SR, CX145D SR	CX160D, CX170E, CX190E
 <b>CAT</b>	300.9D	301.4C, 301.5, 301.7D, 301.7 CR, 301.8, 302 CR	302.4D**, 302.7C/DCR**, 303ECR, 303.5ECR	304ECR, 304.5ECR, 305ECR, 305.5ECR, 306CR	415F2, 416F2, 420F2, 430F2	307E, 307.5, 308ECR, 309CR, 310	450F	311F, 312E, 313F, 314E, 315F	315D, 316E/F, 318E/F
<b>DEVELON</b>			DX35-5	DX42-5, DX55-5, DX60-3, DX62R-3, DX63-3		DX85R-3		DX140-3/5, DX140LCR-3/5, DX140W-5	DX160, DX170-5, DX180-3/5, DX190, DX190W-5
 <b>GEHL</b>		Z17	Z25**, Z35	Z45, Z55		Z80			
 <b>HITACHI</b>		ZX17U-5	ZX26U-5**, ZX30U-5, ZX35U-5"	ZX50U-5, ZX60USB-5		ZX75US-5/7, ZX85USB-5/7		ZX130-6/7, ZX135US-6/7	ZX160-6/7
 <b>HYUNDAI</b>		R17Z-9A	R25Z-9AK**, R30Z-9AK, R35Z-9A	R55-9A, R55W-9A, R60CR-9A		R80CR-9A, R110-7		R125-9A, HX130LCR, R140W-9A, R140-9A, HX140L, HW140, R145-9A, HX145L	R160-9A, R180-9A, R180W-9A, HX160L, HX180L, HW180
<b>IHI/KATO</b>	9VX, 9VXE, HD9V, HD9VX	17VX, 17VXE, HD17V, HD17VXE	25V-4**, HD25V4**, 30V-4, HD30V4, 35N-4, HD55N4, 35V-4, HD35N4	45V-4, HD45V4, 55V-4, HD55V4, 65V-4, HD65V4	55N-4, HD55N4	85V-4, HD85V4		HD512-7, HD514MR-7	
 <b>JCB</b>	8008	8018, 18Z, 19C-1	8029**, 8035, 8040, 1CX, MIDI CX, 2CX, 3CX-COMPACT	8045, 8052, 8060, 45Z-1, 48Z-1, 55Z-1, 57C-1, 67C-1	3CX, 4CX, 1400, 1500, 1700	JS70, 85Z-1, 86C-1, 90Z-1, 100C-1	3CX-SUPER 17, 4CX-SUPER 17	JS131, JS141, JS145, JZ145	JS160
 <b>JOHN DEERE</b>		17G	26G**, 30G, 35G	50G, 60G	310L, 310SL, 315SL, 410L	75G, 85G	710L	130G, 135G, 130P, 135P	160G, 160P
 <b>KOBELCO</b>		SK17SR-5E	SK25SR-6E**, SK30SR-6E, SK35SR-6E	SK45SRX-6E, SK55SRX-6E		SK75SR-3E, SK85CS-3E		SK115SR, SK130, SK135SR, SK140SR-5, ED160-5	SK160-5, SK170-10, ED190
 <b>KOMATSU</b>	PC09-1	PC18MR-3	PC27MR-3**, PC30MR-5, PC35MR-3/5	PC45MR-3/5, PC55MR-3/5	WB146-5, WB156-5	PC78US-10/11, PC88MR-10/11		PC120-8, PC130-11, PC138US-10/11	PC160-8, PC170-11/11
 <b>Kubota</b>	K008-3/5	KX018-4, KX41-3V, U17	KX71-3**, K91-3S2, KX030-4, KX033-4, U255**, U27-4, U35-4, B21, B26, L39, L45, L47, L48, M59**, R420S	KX040-4, XK057-4/5, KX121-3S, U45, U48-5, U55-4/5, R520, SR530, R630	M62	KX080-4, KX080-4S			
 <b>LIEBHERR</b>								R308, R914 Compact, R920 Compact	R317
 <b>Link-Belt</b>						75 X3 SA, 75 MB, 80 X3 SA, 80 SB		130 X3/X4, 145 X3/X4 SA	160 X3/X4
 <b>LIUGONG</b>		9018F	904D, 9035EZTS	906D		908D			915E
 <b>LONKING</b>				CDM6065		CDM6085			CDM6150
 <b>MUSTANG</b>	80M	170Z	250Z**, 350Z	450Z, 550Z		800Z		1000M	
 <b>NEW HOLLAND</b>		E17C, E18B	E26C**, E27B**, E30B/C, E33C, E35B, E37C"	E55BX, E57C, E60C	B95C, B110C				
 <b>SANY</b>		SY16C	SY26U**, SY35U	SY50, SY60		SY75C, SY80U, SY95		SY135C, SY155U	
 <b>TAKEUCHI</b>	TB210R	TB216, TB216H	TB230, TB235-2, TB240	TB260		TB280FR, TB290		TB2150	
 <b>VOLVO</b>		EC20D	ECR25D**, EC27D**, EC35C/D, ECR38D, ECR40D	EC55C, ECR58D, EC60E, EW60E	BL60B, BL70B	ECR85D, ECR88D		EC140E, ECR145E, EWR150E	EC160E, EW160E, EW180E
 <b>WACKER NEUSON</b>	803	ET16, E217, ET20, 1404	EZ28**, EZ36, EZ38, 3503	EZ53, 6003, ET65, EW65		8003, ET90, EW100		ET145	
<b>XCMG/ INTENSUS</b>			XE35U	XE55U, XE35U-E	XE55U	XE75U		XE135B, XE150D/U	
 <b>YANMAR</b>	SV08-1A/B	Vi017-A	Vi025-6A**, Vi035-6A	Vi045-6A/B, Vi055-6A		Vi080-1A, SV100-2A			

\*Note: All manufacturer's names, symbols, numbers & descriptions are used for reference only & does not mean that any part is the product of these manufacturers or approved by these manufacturers.

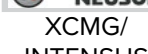

METRIC TON CLASS	20mT	25mT	27mT	35mT	45mT	60mT	80mT	100mT
BACKHOE CLASS								
CLASS	45	55	60	70	100	150	200	250
CWS CLASS	HE200	HE250	HE250	HE300	HE400	HE650	HE850	HE1200
RANGE	R6	R7		R8	R9			
								
	CX210D, CS235C SR, CX245D SR, CX220E	CX250D, CX260E	CX290D*, CX300E*, CX300D*, CX365E SR*	CX350C, CX350D	CX470C, CX490D	CX700B, CX750D	CX800B	
	318C, 319, 320E/F, 321D, 323F, 325F	324E, 325D	326F*, 328D*, 329E/F*, 330F*, 335F*	330D, 336E/F	349E/F, 352F	365C, 374D/F	385C, 390D/F	
DEVELON	DX200-7, DX210, DX210WE, DX225-6/7, DX235LCR-5/7	DX255-5/7	DX300-5/7*, DX350LCR-7*	DX340, DX350-5/7	DX420-5/7, DX450-3, DX490-5/7, DX530-5/7		DX800-7	DX1000-7
								
	ZX180-6, ZX190W-5, ZX190-7, ZX210-6/7, ZX225, ZX245US-6/7	ZX250-6	ZX290-5*, ZX300-6*, ZX345US-7*	ZX350-6, ZX380-6	ZX470-6, ZX490-6	ZX670-6, ZX690-6	ZX870-6, ZX890-6	EX1200-6/7
	R210W-9A, HW210, R220-9A, HX220L, HX235LCR	R260-9A, HX260L	R290*, R300-9A*, HX300L*	R320, R330-9A, R360, R380-9A, HX330L, HX380L	R450, R480-9A, R500, R520-9A, HX480L, HX520L			R1200-9A
IHI/KATO	HD823MR-7							
	JS190, JS220, 220X, JZ235	JS260	JS290*, JS300*	JS330, JS360, JS370	JS460			
	190GW, 200G, 210G, 210P, 245G, 245P	230GW, 250G, 250P	290G*, 300G*, 300P*, 345G*, 345P*	350G, 380G, 350P, 380P	470G	670G	870G	
	SK210-10, SK215, SK230SR-5, SK235SR-2, SK260SR-3, SK270SR-5	SK260-10	SK290*, SK295*, SK300-10*	SK350-10	SK485, SK500-10		SK850-9	
	PC210-10/11, HB215-2, PC228US-10, PC238US-11	PC240-10/11, PC308-8	PC290-10/11*	PC360-10/11, HB365-1/3, PC390-10/11	PC490-10/11	PC600-8, PC650-8/11	PC800-8, PC900-11	PC1250-8/11
								
	R904, R906, R914, R918, R920, R922, R926 Compact	R924, R926	R934, R936, R936 Compact	R934, R938, R945, R946	R945, R946, R950, R954, R956	R960, R964, R966	R970, R974, R976, R980	
	210 X3/X4, 235 X3 SA, 245 X4 SA	250 X3/X4	300 X3/X4*	350 X3/X4	470 X3, 490 X4	700 X2, 750 X4	800 X2	
	922E	925E	930E*	936E	950E			
	CDM6235			CDM6365	CDM6485			
								
								
	SY215C, SY225C	SY235C, SY265C		SY335C, SY365C	SY500H			
								
	EC210D, EW210D, EC220E, EW220E, EW230, ECR235E	EC250E	EC300E*, ECR305C*, ECR355E*	EC350E, EC360, EC380E	EC460, EC480E		EC700C, EC750E	
								
XCMG/ INTENSUS	XE200C, XE210U, XE215C	XE225CA, XE235C, XE250U, XE265C	XE300U	XE360C/U	XE470U/C/CK			
								

\*Please contact sales for proper coupler. \*\* 2.5mT machine model - 3mT bucket may contact boom or boom cylinder guard. Contact Engineering for tip radius of bucket for specific machine.

# QUICK HITCH BUCKETS

Compatible with TAG Couplers



**Quick Hitch Buckets** are like other buckets used for excavation, digging and land clearing, with the added feature of a faster way to exchange different size buckets; this allows similar sized machines to share the same buckets. Quick Hitch buckets are compatible with TAG couplers.

PART #	DESCRIPTION
02HQ012-E00-X156S3-P-027	1 TO 2 METRIC TON MACHINE (12" QUICK HITCH BUCKET)
02HQ018-E00-X156S4-P-027	1 TO 2 METRIC TON MACHINE (18" QUICK HITCH BUCKET)
03HQ012-E00-X156S3-P-027	2.5 TO 3.5 METRIC TON MACHINE (12" QUICK HITCH BUCKET)
03HQ016-E00-X156S4-P-027	2.5 TO 3.5 METRIC TON MACHINE (16" QUICK HITCH BUCKET)
03HQ018-E00-X156S4-P-027	2.5 TO 3.5 METRIC TON MACHINE (18" QUICK HITCH BUCKET)
03HQ024-E00-X156S5-P-027	2.5 TO 3.5 METRIC TON MACHINE (24" QUICK HITCH BUCKET)
05HQ012-E00-X156S3-P-027	5 TO 6 METRIC TON MACHINE (12" QUICK HITCH BUCKET)
05HQ018-E00-X156S4-P-027	5 TO 6 METRIC TON MACHINE (18" QUICK HITCH BUCKET)
05HQ024-E00-X156S5-P-027	5 TO 6 METRIC TON MACHINE (24" QUICK HITCH BUCKET)
05HQ030-E00-X156S5-P-027	5 TO 6 METRIC TON MACHINE (30" QUICK HITCH BUCKET)
08HQ012-E00-X156S3-P-030	BACKHOE + 7 TO 8 METRIC TON MACHINE (12" QUICK HITCH BUCKET)
08HQ018-E00-X156S4-P-030	BACKHOE + 7 TO 8 METRIC TON MACHINE (18" QUICK HITCH BUCKET)
08HQ024-E00-X156S5-P-030	BACKHOE + 7 TO 8 METRIC TON MACHINE (24" QUICK HITCH BUCKET)
08HQ036-E00-X156S6-P-030	BACKHOE + 7 TO 8 METRIC TON MACHINE (36" QUICK HITCH BUCKET)

## QUICK HITCH COUPLERS

The **Quick Hitch™ Coupler** provides a simple and reliable means of adding versatility to your excavator.



PART #	DESCRIPTION
*027 QH*	027 QUICK HITCH COUPLER
*030 QH*	030 QUICK HITCH COUPLER

\*Machine specific item, call for actual part number

## MAIN PIN THUMBS

PART #	DESCRIPTION
*005HT*	2.5 TO 3.5 METRIC TON MACHINE (MAIN PIN HYDRAULIC THUMB)
*025HT*	5 TO 6 METRIC TON MACHINE (MAIN PIN HYDRAULIC THUMB)
*050HT*	BACKHOE + 7 TO 8 METRIC TON MACHINE (MAIN PIN HYDRAULIC THUMB)

\*Machine specific item, call for actual part number

# MX BRUSH CUTTER



**MX Series** mini excavator brush cutters are an extension of Paladin’s successful GroundShark series for skid-steers. Compatible with mini excavators in the 3-8 ton machine class, the MX Series facilitates a variety of applications, including over-fence brush management, embankment and ditch management, and rail right-of-way management. A solid formed T-1 steel deck and reversible AR400 cutting blades powers efficient processing of brush and trees up to 6” in diameter. Equipped with Paladin’s bolt-on mounting system, it offers seamless configuration to a variety of coupling systems. When coupling requirements change, units can be quickly and easily reconfigured without welding or grinding, even in the field.

PART #	DESCRIPTION
BC40MX10	40” MIN-EX BRUSH CUTTER, 3MT, 13-19 GPM, ADAPTER PATTERN A
BC40MX20	40” MIN-EX BRUSH CUTTER, 3MT, 19-26 GPM, ADAPTER PATTERN A
BC50MX10	50” MIN-EX BRUSH CUTTER, 5MT, 17-22 GPM, ADAPTER PATTERN B OR C
BC50MX20	50” MIN-EX BRUSH CUTTER, 5MT, 22-34 GPM, ADAPTER PATTERN B OR C
BC60MX10	60” MIN-EX BRUSH CUTTER, 8MT, 20-28 GPM, ADAPTER PATTERN B OR C
BC60MX20	60” MIN-EX BRUSH CUTTER, 8MT, 28-35 GPM, ADAPTER PATTERN B OR C

## OPERATOR PROTECTION



Patent-pending Tilt Latch™ engages when the cutter is curled up, keeping the blade shield locked down

## AGGRESSIVE CUTS



Swings open when engaged with brush and trees, exposing the blades for deep, aggressive cuts

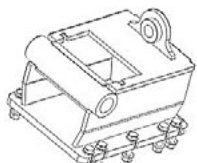

### CP ADAPTERS:

CP Adapters leverage legacy Quick Hitch designs and are commonly used in Rental applications. Paladin CP adapters are designed to work with Paladin manufactured couplers and are available from 1/8 yard size (CP027), 1/4 yard (CP030) and 1/2 yard (CP034), and fit the full family of Strikeforce products.

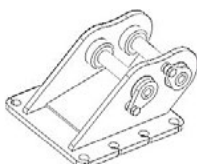

### DEDICATED/CUSTOM ADAPTERS:

These adapters are designed to match the OEM machine interface exactly and include OEM matching Pin groups. As a "custom" offer they have a longer lead-time than the CORE Adapter Systems. Paladin provides Estimate responses for special requests but will include a CORE option recommendation in addition to the Custom response.

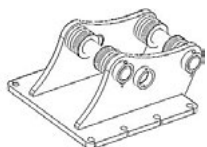

### CORE ADAPTER:

These brackets are used for Pin-Grabber type couplers and Pin-Drive applications where exact pin center duplication is not required. These will not be suitable for Pin-Loc type applications or where pin center match is required to ensure a secure/safe fit-up to the carrier. Lead-time for the CORE will be less due to the standardized inventory possibilities. CORE brackets come complete with Pins and the width adjustment spacers.

**IMPORTANT:** understanding the type of installation is critical in determining whether a CORE Adapter is suitable. Please have the coupler information available, specifically the importance of Pin-Center to center dimensions, when consulting with sales team members.



### QUICK HITCH ADAPTER:

These Adapters are designed to match a machine OEM's proprietary (non-pin) mounting interface. These systems are used to reduce bucket offset in quick attach systems (as opposed to Pin Grabber type), thereby maximizing breakout force with the bucket. These systems can be used reliably with hydraulic attachments and Paladin provides a full offering of these Adapters for the StrikeForce product line. The defining feature of these types of systems is the use of geometry (shape) and not pins to attach the tool to the machine.

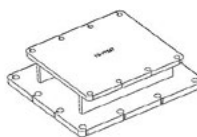

### PATTERN ADAPTER:

These items convert one pattern family to a larger or smaller family to allow use of existing Mounting Adapters wherever possible. This reduces end customer cost and increases the velocity from the factory by leveraging existing designs and on-hand stock. A "Hardware Kit" will be required for the Adapter side.



# HD BUCKETS & DITCH BUCKETS



**Heavy Duty Buckets:** Generally accepted as an industrial quality tool, these buckets are stronger and more wear-resistant than general purpose buckets.

**Ditch Buckets:** Perfect for ditch-cleaning applications. Designed with an abrasion-resistant “double bottom”, which allows for longer bucket life.

PART #	DESCRIPTION
<b>12mT - HD BUCKETS - NO SIDE CUTTERS - NO DEAD PINS</b>	
12HE018-E33D-CJ25S3-J-5130	18" PIN ON BUCKET, VLV EC140/ECR145
12HE018-E33D-CJ25S5-J-2131	18" BUCKET KOBELCO 135SR/SRLC
12HE018-E33D-CJ25S5-J-7120	18" BUCKET JOHN DEERE 120C/CLC/C
12HE018-E33D-CJ25S5-J-9011	18" BUCKET CASE CX130/CX135
12HE018-E33D-CJ30S3-J-9010	18" BUCKET LINKBELT 130LX/135MSR
12HE024-E33D-CJ25S4-J-5130	24" PIN ON BUCKET, VLV EC140/ECR145
12HE024-E33D-CJ25S5-J-2131	24" BUCKET KOBELCO 135SR/SRLC
12HE024-E33D-CJ25S5-J-7120	24" BUCKET JOHN DEERE 120C/CLC/C
12HE036-E33D-CJ25S5-J-5130	36" PIN ON BUCKET, VLV EC140/ECR145
12HE036-E33D-CJ25S5-J-2131	36" BUCKET KOBELCO 135SR/SRLC
12HE036-E33D-CJ25S5-J-7120	36" BUCKET JOHN DEERE 120C/CLC/C
12HE036-E33D-CJ25S5-J-9010	36" BUCKET JCB JS130
12HE036-E33D-CJ25S5-J-9011	36" BUCKET CASE CX130/CX135
12HE042-E33D-CJ25S5-J-2131	42" BUCKET KOBELCO 135SR/SRLC
12HE042-E33D-CJ25S5-J-7120	42" BUCKET JOHN DEERE 120C/CLC/C
12HE042-E33D-CJ25S5-J-9011	42" BUCKET CASE CX130/CX135
12HE048-E33D-CJ25S6-J-5130	48" PIN ON PIN ON BUCKET, VLV EC140/ECR145
12HE048-E33D-CJ25S6-J-2131	48" PIN ON BUCKET KOBELCO 135SR/SRLC
12HE048-E33D-CJ25S6-J-7120	48" PIN ON BUCKET JOHN DEERE 120C/CLC/C
12HE048-E33D-CJ25S6-J-9010	48" PIN ON BUCKET JCB JS130
12HE048-E33D-CJ25S6-J-9011	48" PIN ON BUCKET CASE CX130/CX135
<b>15mT - HD BUCKETS - NO SIDE CUTTERS - NO DEAD PINS</b>	
15HE024-E33D-CJ30S5-J-9020	24" HD EXC BKT FOR CASE CX160
15HE036-E33D-CJ30S5-J-2151	36" BUCKET KOBELCO SK150/SK160/LC
15HE036-E33D-CJ30S5-J-7150	36" BUCKET JOHN DEERE 160C/160CLC/LC
15HE036-E33D-CJ30S5-J-9020	36" BUCKET CASE CX160
15HE042-E33D-CJ30S5-J-2151	42" BUCKET KOBELCO SK150/SK160/LC
15HE042-E33D-CJ30S5-J-7150	42" BUCKET JOHN DEERE 160C/160CLC/LC
15HE042-E33D-CJ30S5-J-9020	42" BUCKET CASE CX160

**20mT - HD BUCKETS - NO SIDE CUTTERS - NO DEAD PINS**

20HE024-E33D-CJ35S3-J-7201	24" PIN ON BUCKET, VLV EC200/EC220/ECR235
20HE024-E33D-CJ35S5-J-7201	24" BUCKET JOHN DEERE 200C/CLC/LC
20HE024-E33D-CJ35S5-J-9030	24" BUCKET CASE CX210/CX225 & JCB 220/JS220
20HE036-E33D-CJ35S5-J-7201	36" PIN ON BUCKET, VLV EC200/EC220/ECR235
20HE036-E33D-CJ35S5-J-2201	36" BUCKET KOBELCO SK210
20HE036-E33D-CJ35S5-J-7201	36" BUCKET JOHN DEERE 200C/CLC/LC
20HE036-E33D-CJ35S5-J-9030	36" BUCKET CASE CX210/CX225 & JCB 220/JS220
20HE042-E33D-CJ35S5-J-7201	42" PIN ON BUCKET, VLV EC200/EC220/ECR235
20HE042-E33D-CJ35S5-J-2201	42" BUCKET KOBELCO SK210
20HE042-E33D-CJ35S5-J-7201	42" BUCKET JOHN DEERE 200C/CLC/LC
20HE042-E33D-CJ35S5-J-9030	42" BUCKET CASE CX210/CX225 & JCB 220/JS220
20HE048-E33D-CJ35S6-J-7201	48" PIN ON BUCKET, VLV EC200/EC220/ECR235
20HE048-E33D-CJ35S6-J-2201	48" BUCKET KOBELCO SK210
20HE048-E33D-CJ35S6-J-7201	48" BUCKET JOHN DEERE 200C/CLC/LC
20HE048-E33D-CJ35S6-J-9030	48" BUCKET CASE CX210/CX225 & JCB 220/JS220

**12mT & 20mT DITCH CLEAN BUCKETS - W/BOLT ON EDGE - INCLUDES DEAD PINS**

7120050D060000N000YNCNP	60" DITCH CLEAN BUCKET, W/BOE, W/DEAD PINS JOHN DEERE 120C/CLC/C
9011050D060000N000YNCNP	60" DITCH CLEAN BUCKET, W/BOE, W/DEAD PINS CASE CX130/CX135
2131050D060000N000YNCNP	60" DITCH CLEAN BUCKET, W/BOE, W/DEAD PINS KOBELCO 135SR/SRLC
2201100D060000N000YNCNP	60" DITCH CLEAN BUCKET, W/BOE, W/DEAD PINS KOBELCO SK210
7201100D060000N000YNCNP	60" DITCH CLEAN BUCKET, W/BOE, W/DEAD PINS JOHN DEERE 200C/CLC/LC
9030100D060000N000YNCNP	60" DITCH CLEAN BUCKET, W/BOE, W/DEAD PINS CX210/CX225 & JCB 220/JS220

# WHEEL LOADER / BACKHOE LOADER MACHINE CLASSIFICATION

The corresponding OEM with the machine size will provide you with the proper class attachment for your equipment.

CLASS (JRB Interchange)					
OEM	100 (Machine Dependent)	200 (416)	300 (416)	500 (416)	600 (418)
CWS Class	WL075/100	WL200	WL250	WL300	WL400
	580N, 580SN 580SNWT, 590N 590SN	521G	621G	721G	821G 921G
	415F2, 416F2 420F2, 430F2	450F, 906M, 907M, 908M, 910M, 926M, IT14G2"	930M	938M	950M 962M
			DL200-5 DL200TC-5	DL250-5 DL250TC-5 DL280-5	DL300-5 DL350-5
<b>HITACHI</b>		ZW120-5B ZW140-5B ZW140PL-5B	ZW150-5B ZW150PL-5B	ZW180-5B ZW180PL-5B	ZW220-5B ZW250PL-5B
			HL940 HL940TM	HL955	HL960 HL965
	3CX 17 4CX 17	409, 411 417	427ZX 427HT	437ZX 437HT	457ZX 457HT
	204L, 304L, 310L, 310SL, 315SL 410L, 244K	710K, 324K 344L, 444K	524L 544L	624L	644K 724K
	45ZV-2	60Z7	"62Z7 67Z7"	70Z7	"80Z7 85Z7"
<b>KOMATSU</b>		WA150-6	WA200-8	WA270PZ-8 WA320PZ-8	WA380-8 WA430-8
<b>LIEBHERR</b>		L526	L538	L546	L550 L556
	CLG816G	CLG835III Z CLG835III TC		CLG842III Z CLG842III TC	CLG856III Z
	W50C W80C				
<b>SANY</b>				SW3025K	SW405K
			LG938L	LG948L	LG958 LG959L
<b>VOLVO</b>	L30G L35G	L50H	L60H L70H	L90H	L110H L120H

\*Note: All manufacturer's names, symbols, numbers & descriptions are used for reference only & does not mean that any part is the product of these manufacturers or approved by these manufacturers.

CLASS (JRB Interchange)						
OEM	700 (420)	800 (420)	900 (422)	1000	1100	1200
CWS Class	WL500/550	WL600	WL700	WL800	WL900	WL1200
	1021G 1121G	1221G				
	966M 972M	980M 982M	986K 988K	990K	992K 993K	994K
	DL420-5 DL450-5	DL550-5				
	ZW310-5B ZW330PL-5B	ZW370-5B ZW370PL-5BXRT	ZW550-5B			
	HL970 HL975	HL980				
						
	744K-III 824K-III	844K-III	944K			
	90Z7 92Z7	95Z7	115Z7	135ZV-2		
	WA470-8 WA480-8	WA500-8	WA600-8		WA800-3 WA900-3	WA1200-6
	L566 L580	L586				
	CLG877III CLG888III					
						
						
						
	L150H L180H	L220H L260	L350H			

\* Machines marked with \* please contact sales for proper coupler. Contact JRB's Customer Service for price and availability on non-current machine attachments.

## GENERAL PURPOSE BUCKET



- Material weight 1800 to 2500 pounds
- Sloped-bottom design allows for maximum fill capabilities and material retention
- Slope bottom increases dump angle by 5° for more efficient dumping capabilities
- Minimum 50 yield steel construction
- Widths and cutting edge hole patterns drilled to OEM standard wear parts specifications

PART #	DESCRIPTION
90D1167	3.0 CYD GP BUCKET W/ EDGE 105.7" WIDE, JRB 416 COUPLER
94D0001-0913	3.0 CYD GP BUCKET W/ EDGE 100.4" WIDE, JRB 416 COUPLER
90D2730	3.5 CYD GP BUCKET W/ EDGE 107.88" WIDE, JRB 416 COUPLER
94D0002-0913	3.5 CYD GP BUCKET W/ EDGE 100.4" WIDE, JRB 416 COUPLER
90D3718	4.0 CYD GP BUCKET W/ EDGE 119.68" WIDE, JRB 418 COUPLER
90D3580	4.25 CYD GP BUCKET W/ EDGE 119.68" WIDE, JRB 418 COUPLER

## SNOW PUSH



The **JRB Snow Pushers** allow for quick and easy installation by pushing with your loader bucket.

PART #	DESCRIPTION
23396-0057	3X3 96" SNOW PUSH BUCKET LIP MOUNT
23320-0057	3X3 120" SNOW PUSH BUCKET LIP MOUNT
23344-0057	3X3 144" SNOW PUSH BUCKET LIP MOUNT
23368-0057	3X3 168" SNOW PUSH BUCKET LIP MOUNT
23396-0913	3X3 96" SNOW PUSH JRB 416 COUPLER
23320-0913	3X3 120" SNOW PUSH JRB 416 COUPLER
23344-0913	3X3 144" SNOW PUSH JRB 416 COUPLER



## CONSTRUCTION FORKS



**JRB®'s Construction Forks** allow you to safely navigate job sites carrying construction materials like pallets, pipes and related equipment with our rugged, newly designed CUFs.

PART #	DESCRIPTION
90K2001-0913	60" X 60" CONSTRUCTION FORKS JRB 416 COUPLER CLASS 200/300/500
90K2006-0913	96" X 60" CONSTRUCTION FORKS JRB 416 COUPLER CLASS 200/300/500
90K2007-0913	96" X 72" CONSTRUCTION FORKS JRB 416 COUPLER CLASS 200/300/500
90K2009-0913	96" X 96" CONSTRUCTION FORKS JRB 416 COUPLER CLASS 200/300/500
90K0005	106" X 60" CONSTRUCTION FORKS JRB 418 COUPLER CLASS 600
90K0105	106" X 72" CONSTRUCTION FORKS JRB 418 COUPLER CLASS 600
90K0751	106" X 96" CONSTRUCTION FORKS JRB 418 COUPLER CLASS 600

## LOADER RAKE



**JRB's Loader Rakes** are ideal for land clearing, raking brush, and piling trees and limbs

PART #	DESCRIPTION
90Z0040	LOADER ROOT RAKE LESS CLAMP, 105" WIDE, JRB 416 COUPLER CLASS 200/300/500
90Z0046	LOADER ROOT RAKE W/ CLAMP, 105" WIDE, JRB 416 COUPLER CLASS 200/300/500
90Z0165	STACKING RAKE W/GRAPPLE CLAMP, 105" WIDE, JRB 416 COUPLER CLASS 200/300/500

## SMALL MOUNTED BREAKERS



**StrikeForce® Small Mounted Breakers** provide cost effective options, and a flexible mounting system allowing installation onto multiple types of machines. These are truly versatile tools that add value to any contractor’s toolbox.

PART #	DESCRIPTION
237250M-BLNK	SFB250 STRIKE FORCE 250# BREAKER, MOUNT AND HOSES ARE NOT INCLUDED
28-11090-0961	MOUNT FOR SFB250 FOR MINI SSL (non Bobcat)
237500M-0022	SFB500 STRIKE FORCE 500# BREAKER W/SSL BRACKET & HOSES
237750M-0022	SFB750 STRIKE FORCE 750# BREAKER W/SSL BRACKET & HOSES
237500R-E0852	SFB500 STRIKE FORCE 500# BREAKER W/INTEGRATED SSL BRACKET & 027QH TOP W/HOSES
23701KC-BLNK	SFB1000 STRIKE FORCE 1000# BREAKER, MOUNT AND HOSES ARE NOT INCLUDED
237015C-BLNK	SFB1500 STRIKE FORCE 1500# BREAKER, MOUNT AND HOSES ARE NOT INCLUDED
28-11092-E0333	030QH TOP CAP FOR SFB1000/1500

## MEDIUM & LARGE MOUNTED BREAKERS



**StrikeForce® Medium Breakers** give the contractor a range of demolition and construction tools to address tasks commonly found on the jobsite. **Strike Force® Large Breakers** These breakers combine the power needed for heavy rock breaking and the speed needed for demolition and general construction work.

### STRIKEFORCE MEDIUM & LARGE MOUNTED BREAKERS

AVAILABLE FOR PURCHASE - CALL FOR SPECIFIC ITEM NUMBER AND PRICING

# HYDRAULIC PLATE COMPACTORS

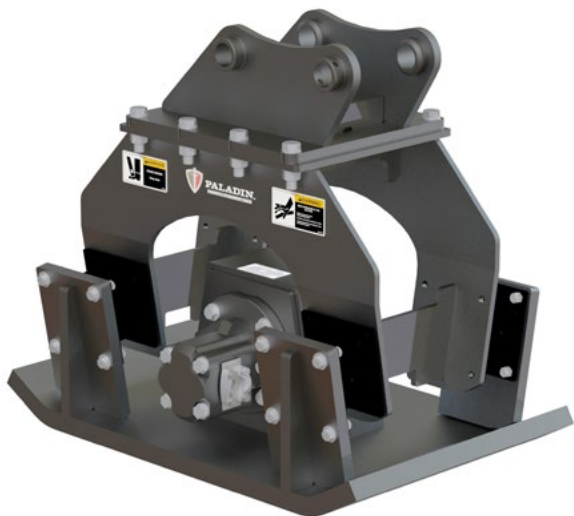

## Paladin® Boom Mounted TPC Plate Compactors

provide the perfect combination of impulse force and frequency for handling trench and surface compaction needs. Each of the TPC models are focused on the needs of the contractor in road construction and repair, embankment preparation, utility and waste drain excavation backfill, as well as special needs in sheet, post, and plate driving for soil.

- “Outboard” shock isolator location provides stability for optimal transmission of impulse for effective compaction
- Shock isolators are angled to reduce damaging shear stresses in the isolator and extend life while providing a performance advantage in delivering compaction forces to the soil

PART #	DESCRIPTION
245250-BLNK	TPC250, 12" HYDRAULIC PLATE COMPACTOR, MOUNT NOT INCLUDED, NO HOSES
245350-BLNK	TPC350, 20" HYDRAULIC PLATE COMPACTOR, MOUNT NOT INCLUDED, NO HOSES
24501K-BLNK	TPC1000, 24" HYDRAULIC PLATE COMPACTOR, MOUNT NOT INCLUDED, NO HOSES
28-11090-E0852	027QH TOP CAP FOR TPC250
28-11091-E0852	027QH TOP CAP FOR TPC350
28-11092-E0333	030QH TOP CAP FOR TPC1000
24502K-BLNK	TPC2K, 24" HYDRAULIC PLATE COMPACTOR, MOUNT NOT INCLUDED, NO HOSES
24504K-BLNK	TPC4K, 26" HYDRAULIC PLATE COMPACTOR, MOUNT NOT INCLUDED, NO HOSES
24510K-BLNK	TPC10K, 36" HYDRAULIC PLATE COMPACTOR, MOUNT NOT INCLUDED, NO HOSES

# COMPACTION WHEELS

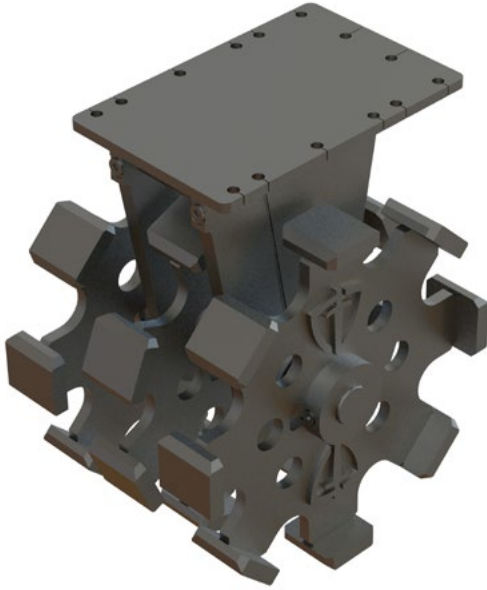

## Paladin® Boom Mounted TWC Compaction Wheels

provide a cost effective, durable, and user friendly compaction method for use in most soils and trench conditions. Strikeforce TWC Compaction Wheels are very effective in consolidating and condensing clay or fine mechanically stable (separates with difficulty) soils where other compaction means are less effective.

- Extended Compaction Pad life through use of abrasion resistant Hardox 450 material
- Enhanced durability through the use of an oversized axle shaft and large diameter bearings to minimize contact loads and lubrication requirement
- All compaction wheels come standard with the Scraper Blade

PART #	DESCRIPTION
24750012-E0852	TWC500-12, 12" COMPACTION WHEEL WITH 027 TOP CAP
24750018-E0852	TWC500-18, 18" COMPACTION WHEEL WITH 027 TOP CAP
24701K12-E0333	TWC1000-12, 12" COMPACTION WHEEL WITH 030 TOP CAP
24701K18-E0333	TWC1000-18, 18" COMPACTION WHEEL WITH 030 TOP CAP
24701K24-E0333	TWC1000-24, 24" COMPACTION WHEEL WITH 030 TOP CAP
24750012-BLNK	TWC500-12, 12" COMPACTION WHEEL, MOUNT NOT INCLUDED
24750018-BLNK	TWC500-18, 18" COMPACTION WHEEL, MOUNT NOT INCLUDED
24701K12-BLNK	TWC1000-12, 12" COMPACTION WHEEL, MOUNT NOT INCLUDED
24701K18-BLNK	TWC1000-18, 18" COMPACTION WHEEL, MOUNT NOT INCLUDED
24701K24-BLNK	TWC1000-24, 24" COMPACTION WHEEL, MOUNT NOT INCLUDED
24704K18-BLNK	TWC4K-18, 18" COMPACTION WHEEL, MOUNT NOT INCLUDED
24704K24-BLNK	TWC4K-18, 24" COMPACTION WHEEL, MOUNT NOT INCLUDED
24704K32-BLNK	TWC4K-18, 32" COMPACTION WHEEL, MOUNT NOT INCLUDED

## DROP HAMMERS



The Cyclone Drop Hammer was developed specifically for the demolition of concrete flat-work allowing for easier removal in smaller and more manageable sizes. This enables reducing the size of the excavator required if pulling up the slab, better compaction for stock-piling and transportation, and smaller material handling for crusher feed.

- Up to 5X More Power to Weight than conventional hydraulic breakers
- Less Maintenance with no upper or lower bushings to grease or replace, no accumulators to re-charge, and no wear plates to rebuild or replace.
- Reduced Carrier Wear and Operator Fatigue the hammer is designed to have the tool rest directly on the concrete surface. This ensures that the impact load is transmitted squarely down to the concrete.

MODEL	PART #	DESCRIPTION
DH3500	DH3500	3,500 FT LBS / 4,746 NM, 32 BLOWS PER MINUTE DROP HAMMER WITH SKID STEER MOUNTING BRACKET
DH9000	DH9000	9,000 FT LBS / 12,200 NM, 23 BLOWS PER MINUTE DROP HAMMER WITH SKID STEER MOUNTING BRACKET



**SELECTION.  
INNOVATION.  
PERFORMANCE.**

